

Amica™ 2 2x4

LED

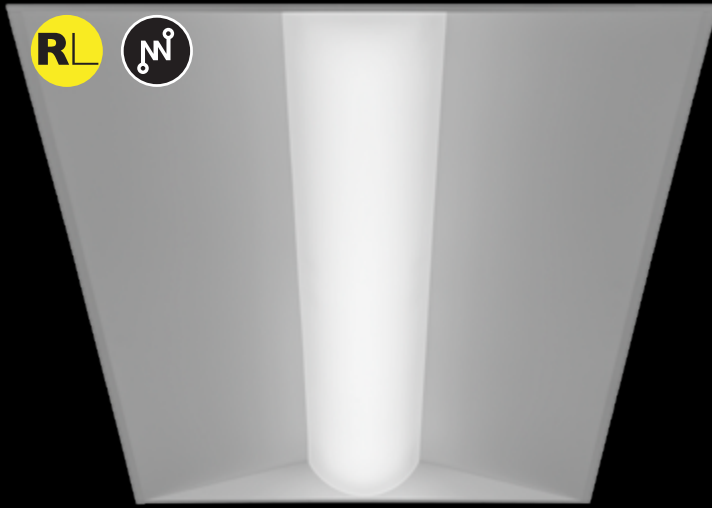

lens detail

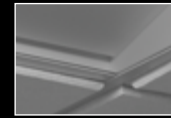

air return

DIMENSIONAL DATA

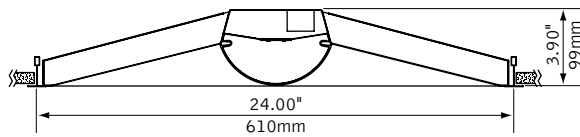

led options

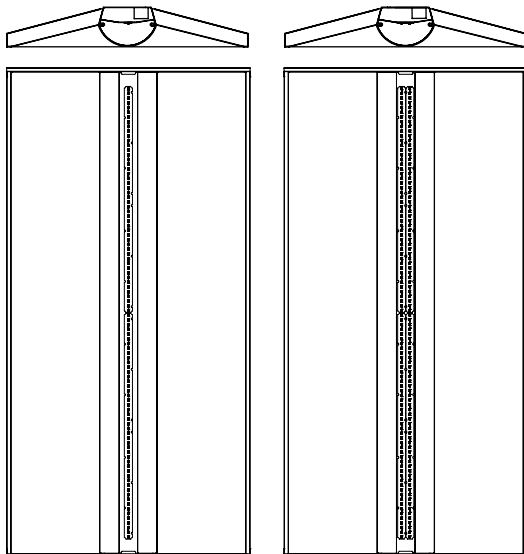

Standard (2 LED Boards)

High Efficiency (4 LED Boards)

FEATURES

Architectural recessed LED luminaire with classic lines to complement architecture.

Center ribbed diffuser masks LED brightness to create even illumination.

3.9" housing depth ideal for shallow plenum applications.

Access from below the ceiling for easy maintenance.

Connected Solutions: Integrates with wired and wireless building lighting control systems.

PERFORMANCE

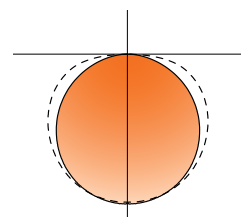

PRODUCT OVERVIEW

Lumen Output:	4000-6000lm
Wattage:	30-49W
LPW:	125-140
SDCM:	3

High Performance
4000 Lumens (4000LH)
Delivered Lumens: 4000lm
Total System Watts: 30W



Photometric performance is measured in accordance with IESNA LM-79. Visit focalpointlights.com for complete photometric data. Visit designlights.org/QPL for model specifics.

MOUNTING INFORMATION

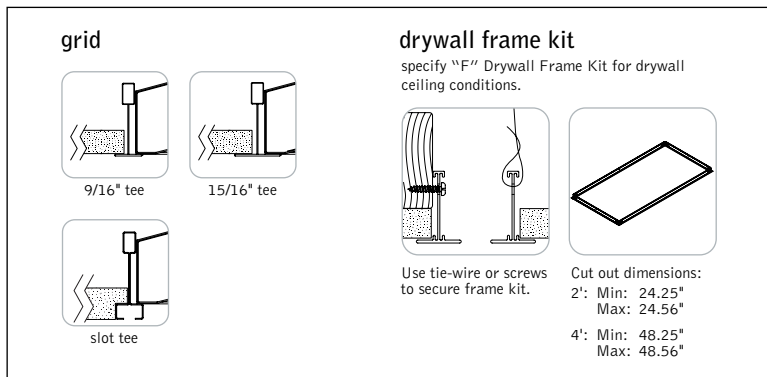

SPECIFICATIONS

LED System

LED module incorporates premium LEDs on a robust platform to achieve excellent thermal management. LEDs are placed to promote a uniform appearance. Available in 3000K, 3500K or 4000K with CRI>80, 3 SDCM. LED modules and drivers are replaceable from below.

Construction

One piece 24 Ga. steel reflector and housing. Bottom access 24 Ga. steel driver compartment. Top access plate for electrical connection. Positional brackets supplied as standard. Unit weight: 16 lbs.

Optic

24 Ga. steel reflectors finished in matte satin white powder coat. .084" thick frosted white acrylic diffuser with linear micro-prism pattern.

Electrical

Standard 120-277V driver includes 0-10V analog dimming. Power factor > .9. LD1 not Right Light as standard, consult factory.

Emergency Battery

Bodine BSL310LP. Emergency output—10 watts for 90 minutes. Maximum mounting height: 22.5ft.

Labels

UL and cUL Listed. Suitable for Dry or Damp Locations, indoor use only.

Finish

Polyester powder coat applied over a multi-stage pre-treatment.

Lumen Maintenance

Reported: L70 at >72,000 hours Calculated: L70 at 114,000 hours
L80 at >72,000 hours L80 at 73,000 hours
Derived from EPA TM-21 calculator. Based on typical conditions, consult factory for additional data.

Reliability

At Focal Point, our products are designed to stand the test of time. Each luminaire is engineered using superior components, manufactured with the utmost care and rigorously tested. Contact us for reliability data.

Warranty

LED system rated for operation in ambient environments up to 25°C. 5-year limited warranty.

PERFORMANCE CHART

	Delivered Lumens	Tested System Watts	LPW
4000 Lumens	4000L	32	127
	4000LH	30	140
4500 Lumens	4500L	35	128
	4500LH	34	139
5000 Lumens	5000L	39	129
	5000LH	38	136
5500 Lumens	5500L	43	127
	5500LH	42	134
6000 Lumens	6000L	49	125
	6000LH	46	133

Based on 3500K. *Lumen output may vary +/- 8%. Actual wattage may vary +/- 5%

ORDERING

Luminaire Series	FAM2
Amica 2	FAM2
Nominal Size	24
2' x 4'	24
Shielding	ACR
Ribbed Acrylic Diffuser	ACR
Lumen Output	
Standard (2 LED Boards)	
4000 Lumens	4000L
4500 Lumens	4500L
5000 Lumens	5000L
5500 Lumens	5500L
6000 Lumens	6000L
High Efficiency (4 LED Boards)	
4000 Lumens	4000LH
4500 Lumens	4500LH
5000 Lumens	5000LH
5500 Lumens	5500LH
6000 Lumens	6000LH
(Consult factory for higher lumen outputs)	
Color Temperature	
3000K	30K
3500K	35K
4000K	40K
(Consult factory for additional CCT and CRI options)	
Circuit	1C
Single Circuit	1C
Voltage	
120/277 UNV Volt	UNV
347 Volt	347
(LD1 & CLM1 only.)	
Control System & Dimming Level	
0-10V - 1% Dimming	L11
0-10V - 10% Dimming	LD1
(Not Right Light as standard, consult factory.)	
Lutron Hi-Lume EcoSystem (LDE1) - 1% Dimming	LH1
Lutron 5-Series EcoSystem (LDE5) - 5% Dimming	LU5
Step Dimming	SD5
DALI 1% Dimming	D11
Acuity nLight - 1% Dimming	NLT1
(Not available with Chicago Plenum, Recessed grid & drywall frame kit mounting only.)	
Enlighted Smart Sensor - 5% Dimming	ENL5
Osram Connected Lighting Module - 1% Dimming	CLM1
(Compatible with Daintree Networks & Osram ENCCELUM and Simplux systems)	
Wattstopper DLM - 1% Dimming	DLM1
(Recessed grid & drywall frame kit mounting only)	
Mounting	
Grid	G
Drywall Frame Kit	F
(Cut out dimensions: Min: 24.25"/Max: 24.56" Min: 48.25"/Max: 48.56")	
Surface Mount	SM
24" Aircraft Cable	C24
48" Aircraft Cable	C48
96" Aircraft Cable	C96
Factory Options	
Air Return	AR
(Overall height for luminaire with Air Return is 4.4")	
Chicago Plenum	CP
Emergency Battery Pack with Integral Test Switch	EM
6' New York City Flex Whip (120V)	FN11
6' New York City Flex Whip (277V)	FN12
6' Flex Whip	FW
Finish	WH
Matte Satin White	WH

QS 5/10 DAY* Options in orange qualify for the Quickship program. 5-day up to 100 pieces, 10-day up to 300 pieces. Refer to Quickship Guide for complete details.

Focal Point provides flexibility in meeting the needs of each project by integrating with several building lighting control systems. A variety of sensors, drivers and other components can be specified that allow the luminaires to communicate with wired and wireless networks. All zoning can be digitally reconfigured through the application software. Daylight harvesting, occupancy sensing, integration with HVAC systems, and individual controls enable the monitoring and modulating of light levels and temperature in order to save energy, reduce costs and maximize occupants' comfort.

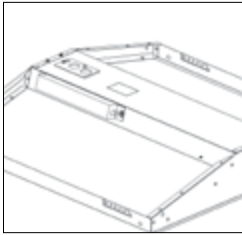

nLight® provides a two-way wired digital lighting system allowing for on/off and dimming functionality, occupancy sensing, and multi-zone daylight harvesting.

Acuity nLight - 1% Dimming (NLT1)
Acuity Model #nEPS-60-IO

CAT-5 Cable provided by others. Serial labels will be provided on outside of luminaires and control unit.



Enlighted smart sensor allows for occupancy sensing, daylight harvesting, energy usage, temperature and light level control. Communicates wirelessly with the Enlighted network.

Enlighted Smart Sensor - 5% Dimming (ENL5)
Enlighted Model #CS-D2



Connected Lighting Module (CLM) enables each luminaire to be independently controlled and configured. Communicates wirelessly with Daintree Networks®, Osram ENCELIUM®, Osram Simplux™ and other networks using the ZigBee® HA communication protocol to allow for on/off and dimming functionality, occupancy sensing and multi-zone daylight harvesting.

Osram CLM - 1% Dimming (CLM1)
Osram Model #ZBHA-CLM DIM

Serial labels will be provided on outside of luminaires and control unit.

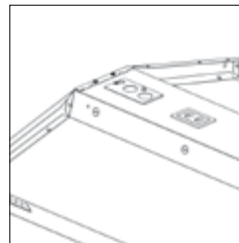

A Digital Lighting Management (DLM) system that provides two-way wired communication between networked luminaires and control system to allow for on/off and dimming functionality, occupancy sensing and multi-zone daylight harvesting.

Wattstopper DLM - 1% Dimming (DLM1)
Wattstopper Model #LMFC-011

CAT-5 Cable provided by others. Serial labels will be provided on outside of luminaires and control unit.

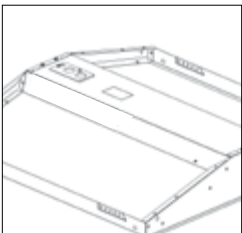

A two-way digital network that enables on/off and dimming functionality, occupancy sensing, and multi-zone daylight harvesting working with Quantum®, Energi Savr Node™, and Energi TriPak® using EcoSystem® communication protocol.

Lutron Hi-Lume EcoSystem - 1% Dimming (LH1)
Lutron Model #LDE1

Lutron 5-Series EcoSystem - 5% Dimming (LU5)
Lutron Model #LDE5

CONNECTED SOLUTIONS DETAILS

Connected Solution	Model #	Protocol	Compatible Networks*	Occupancy	Daylight	Temperature Reporting	Communication to Luminaire	Drivers
Acuity nLight (NLT1)	nEPS-60-IO**	nLight	nLight	Enabled	Enabled	No	Wired	eldoLED ECOdrive , eldoLED SOLOdrive
Enlighted Smart Sensor (ENL5)	CS-D2**	Enlighted RF	Enlighted	Integrated	Integrated	Yes	Wireless	Philips Xitanium SR
Legrand Wattstopper DLM (DLM1)	LMFC-011**	DLM	DLM	Enabled	Enabled	No	Wired	Philips SimpleSet , Osram Optotronic
Lutron EcoSystem (LH1 & LU5)	LDE1,** LDE5**	EcoSystem	Quantum, Energi Savr Node, Energi TriPak	Enabled	Enabled	No	Wired	Lutron Hi-Lume Lutron 5-Series
Osram CLM (CLM1)	ZBHA-CLM**	ZigBee HA	Osram ENCELIUM & Simplux, Daintree Networks	Enabled	Enabled	No	Wireless	Osram Optotronic

*Not all compatible networks may be listed. **For performance data and additional control system details please visit the connected solutions manufacturer websites. Primary drivers are listed in bold. To specify a particular driver please consult factory.