

Aerion® 2x4

LED

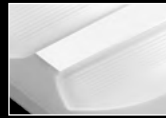

standard diffuser

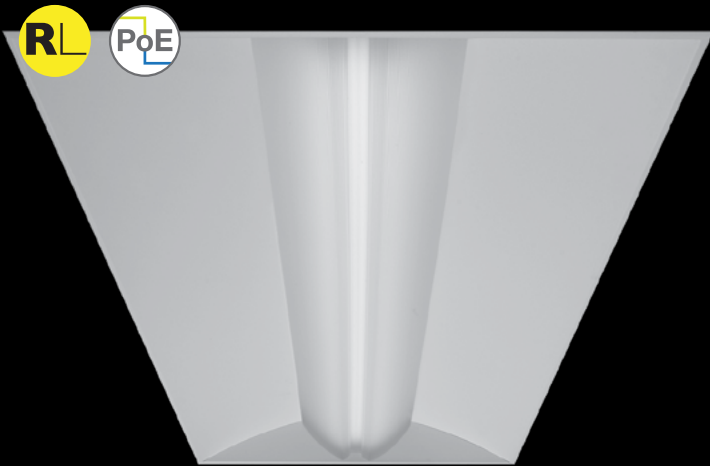

round accent strip



square accent strip



red insert



green insert



blue insert

DIMENSIONAL DATA

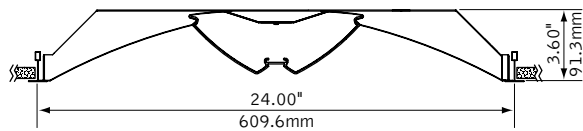

led options

Standard

High Efficiency

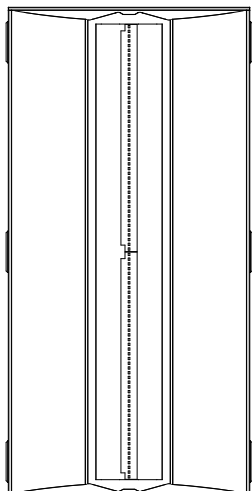

2 LED boards

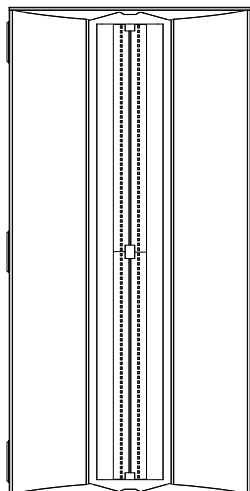

4 LED boards

FEATURES

Architectural recessed LED luminaire.

Aerion's sweeping curves and contemporary lines complement architecture.

Aerion's center lamp chamber provides minimal contrast between the diffuser and side reflectors creating even illumination and comfort.

Aerion features a shallow 3.6" housing depth which flies under the radar of most plenum obstructions.

Stylized sloped endcaps highlight Aerion's distinctive look.

Acrylic diffuser has been designed with an upper and lower track that accepts individual or combinations of accent strips.

PoE compatible: Integrates with Power over Ethernet lighting systems via standard, low-voltage wires.

PERFORMANCE

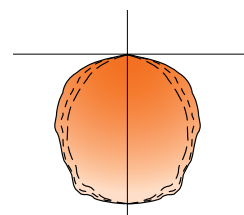

PRODUCT OVERVIEW

Lumen Output: 4000-6000lm

Wattage: 34-54W

LPW: 102-118

SDCM: 3

High Performance
5000 Lumens (5000LH)
Delivered Lumens: 5000lm
Total System Watts: 44W

Photometric performance is measured in accordance with IESNA LM-79.
Visit focalpointlights.com for complete photometric data.

fixture:

project:

MOUNTING INFORMATION

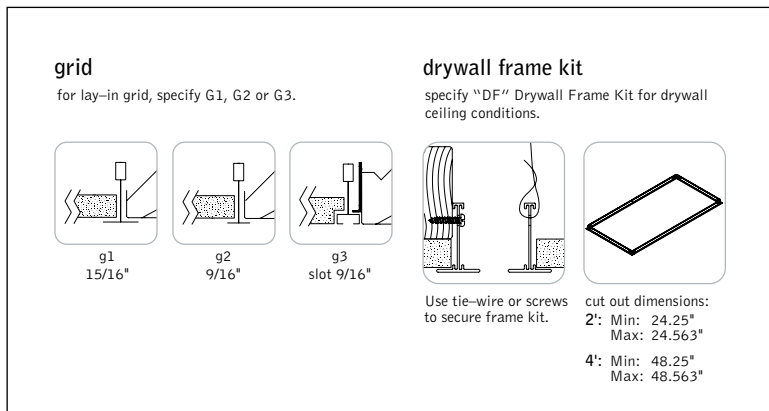

SPECIFICATIONS

LED System

Proprietary linear LED module incorporates premium LEDs on a robust platform to achieve excellent thermal management. LEDs are placed to promote a uniform appearance. Available in 3000K, 3500K or 4000K with CRI>80, 3 SDCM. 0-10V dimming driver standard. LED modules are replaceable from below.

Construction

One piece 20 Ga. steel reflector and housing. Side access 20 Ga. steel ballast compartment. Positional brackets supplied as standard. Unit weight: 25 lbs.

Optic

20 Ga. steel reflectors finished in matte satin white powder coat. .095" thick frosted white acrylic lamp diffusers with linear micro-prism pattern. Optional .020" thick acrylic accent strip available in round or square pattern.

Electrical

Standard 120-277V driver includes 0-10V analog dimming. Power factor > .9. Optional EcoSystem dimming drivers from Lutron available. PoE compatible: Integrates with Power over Ethernet lighting systems via standard, low-voltage wires.

Emergency Battery

Bodine BSL310-CAN. Emergency output—10 watts for 90 minutes. Grid and Drywall Frame kit mounting only.

Labels

UL and cUL Listed. Suitable for Dry or Damp Locations, indoor use only.

Finish

Polyester powder coat applied over a multi-stage pre-treatment. Optional Matte Satin White with anti-microbial coating provides 99.99% protection against a broad spectrum of micro-organisms.

Lumen Maintenance

Reported: L90 at >61,000 hours Calculated: L90 at 114,000 hours
Derived from EPA TM-21 calculator. Based on typical conditions, consult factory for additional data.

Reliability

At Focal Point, our products are designed to stand the test of time. Each luminaire is engineered using superior components, manufactured with the utmost care and rigorously tested. Contact us for reliability data.

Warranty

LED system rated for operation in ambient environments up to 25°C. 5-year limited warranty.

PERFORMANCE CHART

	Delivered Lumens	Tested System Watts	LPW
4000 Lumens	4000L	37	108
	4000LH	34	118
4500 Lumens	4500L	43	105
	4500LH	39	115
5000 Lumens	5000L	48	104
	5000LH	44	114
5500 Lumens	5500L	54	102
	5500LH	48	115
6000 Lumens	6000LH	54	111

Lumen output may vary +/- 5%. Actual wattage may vary +/- 5%

Focal Point LLC reserves the right to change specifications for product improvement without notification.

ORDERING

Luminaire Series	FARL
Aerion LED	FARL
Nominal Size	24
2' x 4'	24
Shielding	
Acrylic Diffuser	AC
Acrylic Diffuser with Round Accent Strip	RA
Acrylic Diffuser with Square Accent Strip	SA
Optional Color Inserts	
(Leave blank for no color)	
Red	R
Green	G
Blue	B
Lumen Output	
Standard	
4000 Lumens	4000L
4500 Lumens	4500L
5000 Lumens	5000L
5500 Lumens	5500L
High Efficiency	
4000 Lumens	4000LH
4500 Lumens	4500LH
5000 Lumens	5000LH
5500 Lumens	5500LH
6000 Lumens	6000LH
Color Temperature	
3000K, 80+ CRI	30K
3500K, 80+ CRI	35K
4000K, 80+ CRI	40K
Circuit	1C
Single Circuit	1C
Voltage	
120 Volt	120
277 Volt	277
UNV Volt	UNV
(Cannot be specified with EM option)	
Low Voltage	LV
Control System & Dimming Level	
0-10V - 1% Dimming	L11
0-10V - 10% Dimming	LD1
5000 Lumens and higher: (2) drivers supplied, (2) EcoSystem addresses consumed	
Low Voltage, PoE compatible	LVN
(No driver. Not available with EM or EC. LV Voltage only)	
Lutron Hi-Lume EcoSystem (LDE1) - 1% Dimming	LH1
Step Dimming	SD5
(Grid and drywall mounting only)	
DALI - 1% Dimming	D11
(Consult factory)	
(*5000 Lumens and higher: (2) drivers supplied, (2) loads consumed. Grid and drywall mounting only)	
Mounting	
24" Aircraft Cable	C24
48" Aircraft Cable	C48
96" Aircraft Cable	C96
15/16" Grid	G1
9/16" Grid	G2
9/16" Slot Tee	G3
Drywall Frame Kit	F
(Cut out dimensions: Min: 24.25"/Max: 24.563" Min: 48.25"/Max: 48.563")	
Surface Mount	SM
Factory Options	
Air Return	AR
(Overall height for luminaire with Air Return is 4.26")	
Chicago Plenum	CP
Emergency Battery Pack with Integral Test Switch	EM
6' New York City Flex Whip	FNY
6' Flex Whip	FW
Finish	
Matte White Housing	WH
Matte Satin White with Anti-Microbial Coating	WHA



Options in orange qualify for the Quickship program. 5-day up to 100 pieces, 10-day up to 300 pieces. Refer to Quickship Guide for complete details.