

# Avenue® A

FLUORESCENT

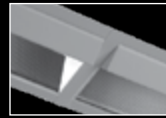

drywall row mount

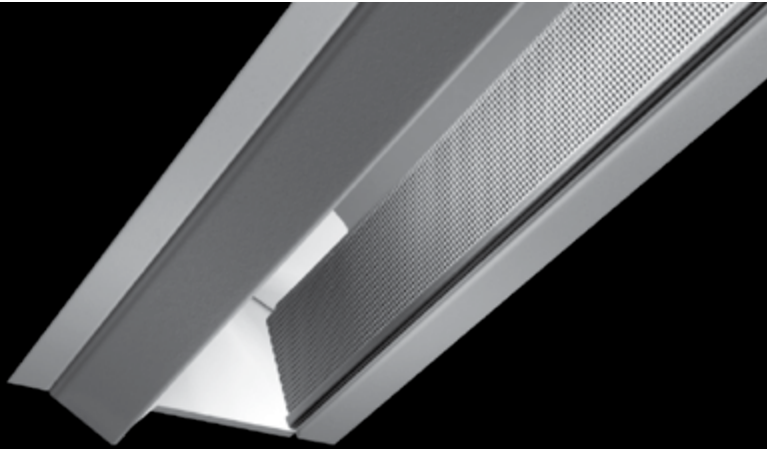
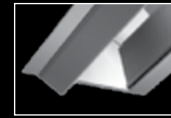

open optic

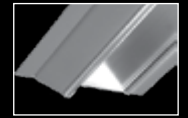

clear lens

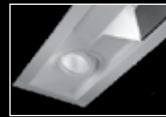

mr16 companion

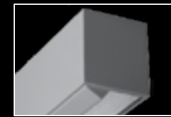

linear



recessed wall mount

## DIMENSIONAL DATA

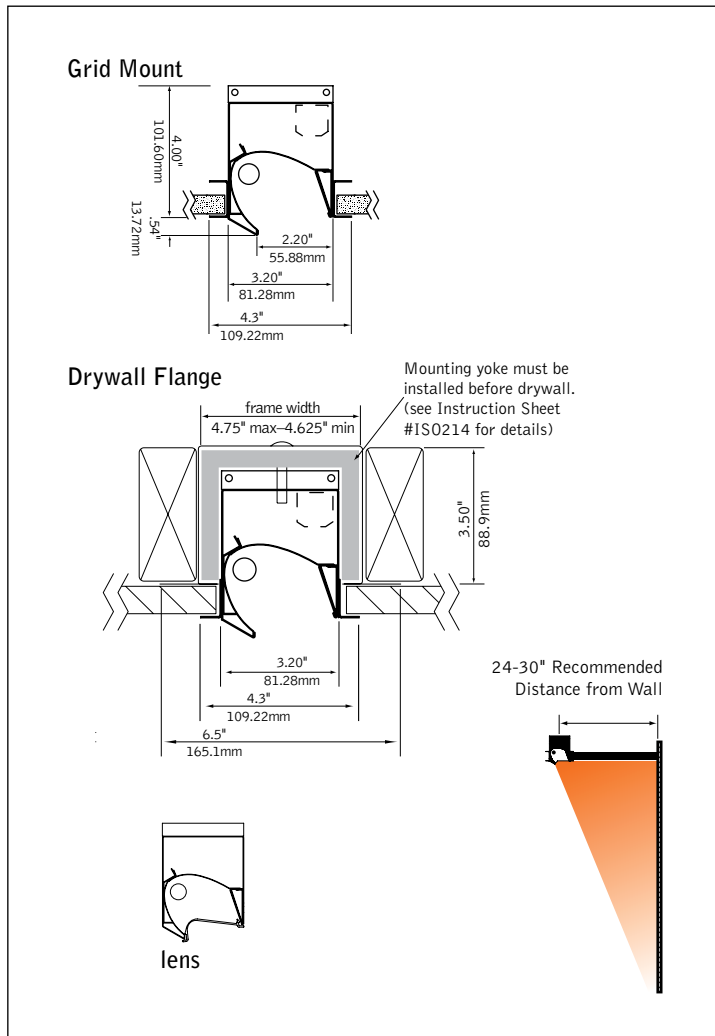

## FEATURES

Narrow aperture high performance T5/T5HO asymmetric wall wash.

Precision micro-optic delivers shadow free illumination from the ceiling to the floor.

Features 2" narrow aperture for clean unobtrusive aesthetic.

Drywall installation is available, which allows for both individual or row mount capability.

Great solution for conference rooms, highlighting artwork, corridors, white board or any application that requires high levels of vertical illumination.

## PERFORMANCE

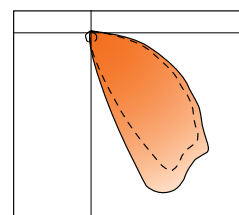

### PRODUCT OVERVIEW

Lumen Output: 772-4004lm  
Wattage: 16-91W  
Lamping: T5, T5HO

1-Lamp T5HO  
57% Efficient  
1933 cd @ 25°

Visit [focalpointlights.com](http://focalpointlights.com) for complete photometric data.

**MOUNTING INFORMATION**

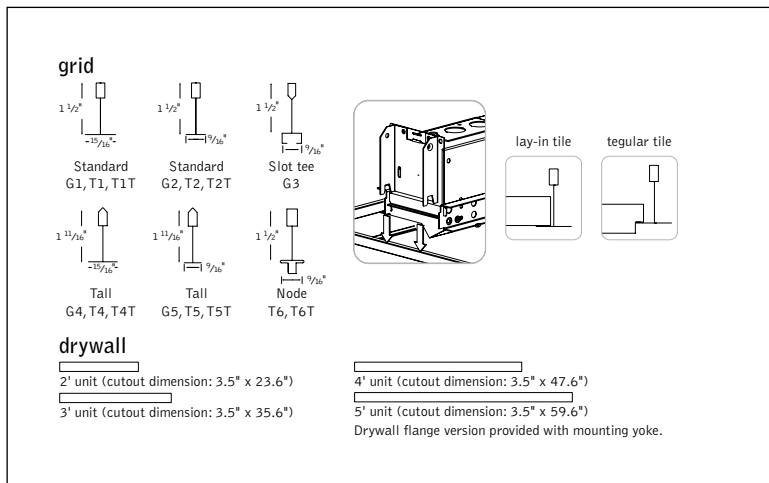

**SPECIFICATIONS**

**Construction**

One-piece 20 Ga. steel housing. Grid luminaires include 20 Ga. steel, .5" wide universal flange rail. Drywall flange option is provided with 20 Ga. steel, .5" wide flange kit and 20 Ga. galvanized steel mounting yoke. 2' unit weight: 5 lbs., 3' unit weight: 6 lbs., 4' unit weight: 7 lbs., 5' unit weight: 8 lbs.

**Optic**

.020" specular aluminum upper reflector and .020" semi-specular lower reflector. 24 Ga. perforated matte black diffuser with 24% opening. Please Note: radial cut-off louver FAVA-RL cannot be field installed on the non-shielded profile FAVA-NS.

**Electrical**

Luminaires are individually wired for specified circuits. Thru-wiring not available. Electronic ballasts are thermally protected and have a Class "P" rating. Optional dimming ballasts available. Consult factory for dimming specifications and availability.

**Labels**

UL and cUL listed.

**Finish**

Polyester powder coat applied over a 5-stage pre-treatment. Perforated diffuser always finished in Matte Black.

**ORDERING**

**Luminaire Series**

**FAVA**

Avenue A FAVA

**Shielding**

No Shielding, Open Optic NS  
Snap-on Clear Lens CL

(Radial cut-off louver FAVA-RL cannot be field installed on the FAVA-NS or FAVA-CL)

**Lamping**

One Lamp T5 1T5  
One Lamp T5HO 1T5HO

**Circuits**

Single Circuit 1C

**Voltage**

120 Volt 120  
277 Volt 277  
347 Volt 347

(Consult factory for dimming options)

120/277 UNV UNV

(Not available with 1-lamp T5HO dimming or EM)

**Ballast**

Electronic Program Start <10% THD S  
0-10V D7  
Lutron 1% 3-wire DH  
Lutron 1% H-Series DK

**Ceiling Configurations\***

Drywall Flange F

	Std. 15/16" Lay-in	G1
	Std. 15/16" Tegular	T1
	Std. 15/16" Tegular, against Tee	T1T
	Std. 9/16" Lay-in	G2
	Std. 9/16" Tegular	T2
	Std. 9/16" Tegular, against Tee	T2T
	9/16" Slot-tee Tegular	G3
	Tall 15/16" Lay-in	G4
	Tall 15/16" Tegular	T4
	Tall 15/16" Tegular, against Tee	T4T
	Tall 9/16" Lay-in	G5
	Tall 9/16" Tegular	T5
	Tall 9/16" Tegular, against Tee	T5T
	Node 9/16" Tegular	T6
	Node 9/16" Tegular, against Tee	T6T

**Factory Options**

Chicago Plenum CP  
Emergency Battery Pack\* EM  
(3' & 4' Luminaires Only)  
Positional Clips EQ  
6' New York City Flex Whip FNY  
6' Flex Whip FW  
HLR/GLR Fuse FU  
Include 3000K Lamp\* L830  
Include 3500K Lamp\* L835  
Include 4100K Lamp\* L841

**Finish**

Matte White Housing WH  
Titanium Silver TS  
Matte Black Housing BK

(Perforated diffuser always painted black)

**Luminaire Length**

2' Nominal Housing 2'  
3' Nominal Housing 3'  
4' Nominal Housing 4'  
5' Nominal Housing 5'

(For row mount in drywall ceiling, specify luminaire run length, ie 24')

# Avenue® A

FLUORESCENT - OPEN OPTIC

## FAVA-NS-1T5HO-1C-120-S-G-WH-4'

Filename: FAVANS1T5H.IES  
Test #: 12355.0

Lumens: 2861lm  
Efficiency 57%

### CANDLEPOWER DISTRIBUTION

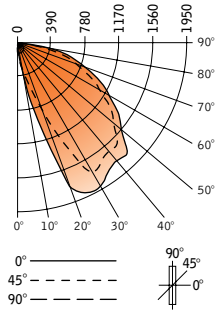

Vertical Angle	Horizontal Angle					Zonal Lumens
	0°	22.5°	45°	67.5°	90°	
0°	108	108	108	108	108	
5°	276	256	214	154	101	13
15°	919	771	499	291	102	85
25°	1933	1873	1300	415	101	279
35°	1832	1799	1695	707	96	408
45°	1806	1775	1647	1296	88	610
55°	1434	1416	1329	1108	74	580
65°	1072	1052	962	811	56	473
75°	655	631	568	458	39	294
85°	317	294	224	129	14	119
90°	183	165	112	40	2	
95°	0	0	0	0	0	0
105°	0	0	0	0	0	0
115°	0	0	0	0	0	0
125°	0	0	0	0	0	0
135°	0	0	0	0	0	0
145°	0	0	0	0	0	0
155°	0	0	0	0	0	0
165°	0	0	0	0	0	0
175°	0	0	0	0	0	0
180°	0	0	0	0	0	0

### LUMEN SUMMARY

Zone	Lumens	% Lamp	% Fixture
0-30°	376	7.5	13.2
0-40°	784	15.7	27.4
0-60°	1975	39.5	69.0
0-90°	2861	57.2	100.0
<b>Total Luminaire 0-180°</b>	<b>2861</b>	<b>57.2</b>	<b>100.0</b>

Go to [www.focalpointlights.com](http://www.focalpointlights.com) for additional photometric data.

# Avenue® A

## FLUORESCENT GRID CEILING CONFIGURATIONS



Avenue A is configured at our factory to integrate easily with your specified grid type, tile style and fixture position. Please review the below options and choose the mounting code that matches your application.

