

Avenue® B

FLUORESCENT

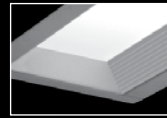

corrugated regress trim

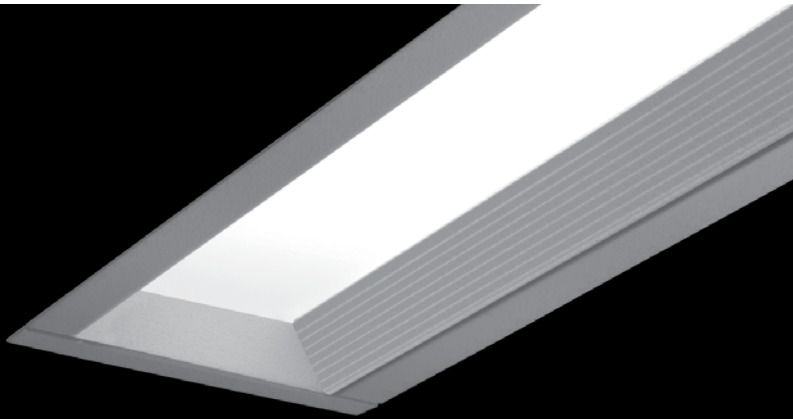
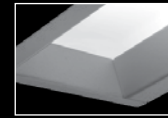

solid regress trim

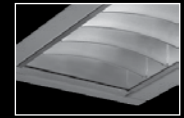

concave louver

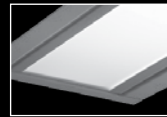

flush lens

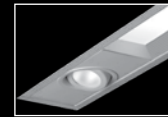

mr16 companion

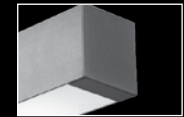

linear companion

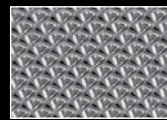

microglow™ lens

DIMENSIONAL DATA

Grid Mount (Regress Trim Shown)

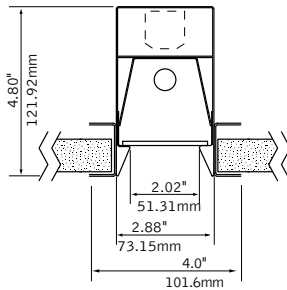

Drywall Flange (Regress Trim Shown)

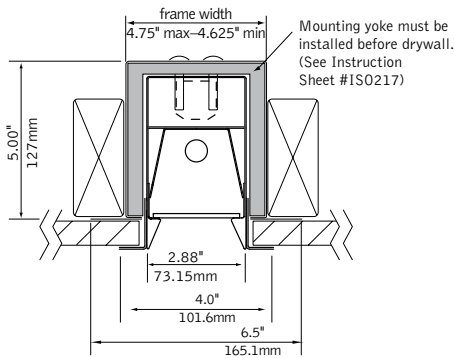

Louver

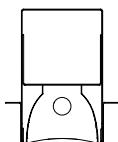

Flush Lens

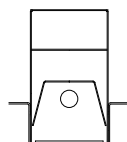

FEATURES

Narrow 3" slot, T5 fluorescent with opaque satin lens.

Shielding options include corrugated, solid regressed trim, concave louver as well as flush lens.

Drywall installation is available, which allows for both individual or row mount capability.

Avenue® B is a great solution for general illumination in a narrow aperture.

PERFORMANCE

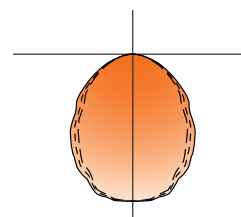

Flush lens
1-Lamp T5HO
61% Efficient
1339 cd @ 5°

PRODUCT OVERVIEW

Lumen Output: 667-4235lm
Wattage: 16-91W
Lamping: T5, T5HO

Visit focalpointlights.com for complete photometric data.

fixture:

project:

MOUNTING INFORMATION

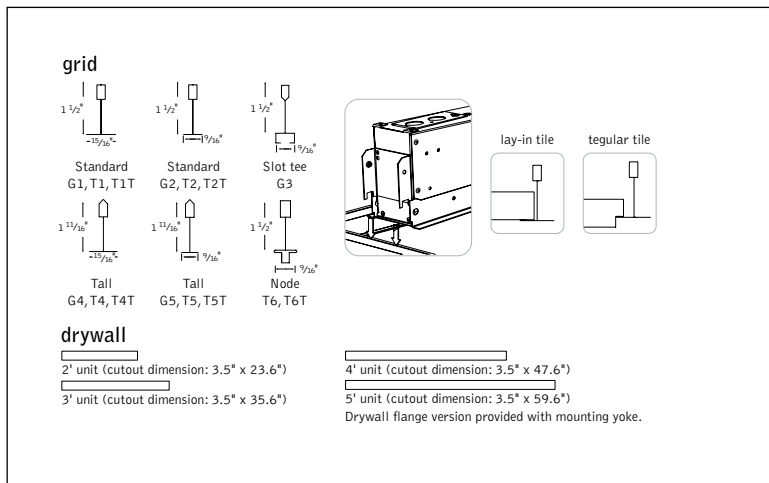

SPECIFICATIONS

Construction

One-piece 20 Ga. steel housing. Corrugated and solid regress trim constructed of extruded aluminum finished in Matte Satin White. Grid luminaires include 20 Ga. steel, .5" wide flange rail finished in Matte Satin White. Drywall flange option is provided with 20 Ga. steel, .5" wide flange kit and 20 Ga. galvanized steel mounting yoke. 2' unit weight: 5 lbs., 4' unit weight: 7 lbs., 5' unit weight: 8 lbs.

Optic

22 Ga. steel reflectors finished in High Reflectance White powder coat. Frosted Acrylic lens diffuser .118" thick. Clear Acrylic MicroGlow™ diffuser .125" thick with miniature prismatic pattern. Concave parabolic louver: 1"H x 1" frequency fabricated of low iridescent, semi-specular premium grade aluminum. Louver can be specified with matte white finish.

Electrical

Luminaires are individually wired for specified circuits. Thru-wiring not available. Electronic ballasts are thermally protected and have a Class "P" rating. Optional dimming ballasts available. Consult factory for dimming specifications and availability.

Labels

UL and cUL listed.

Finish

Polyester powder coat applied over a 5-stage pre-treatment.

ORDERING

Luminaire Series	FAVB	FAVB
Avenue B	FAVB	
Shielding		
Corrugated Regressed Trim Frst.Lns	CR	
Solid Regressed Trim Frosted Lens	SR	
Concave Parabolic Louver	PL	
Flush Frosted Lens	FL	
Corrugated Regressed Trim with MicroGlow™ Lens	CRM	
Solid Regressed Trim with MicroGlow™ Lens	SRM	
Flush MicroGlow™ Lens	FLM	
White Concave Parabolic Louver	PW	
Lamping		
One Lamp T5	1T5	
One Lamp T5HO	1T5HO	
Circuits		1C
Single Circuit	1C	
Voltage		
120 Volt	120	
277 Volt	277	
347 Volt	347	
<small>(Consult factory for dimming options)</small>		
UNV	UNV	
<small>(Cannot be specified with 1T5HO dimming or EM option)</small>		
Ballast		
Electronic Program Start <10% THD	S	
0-10V	D7	
Lutron 1% 3-wire	DH	
Lutron 1% H-Series	DK	
Ceiling Configurations*		
Drywall Flange	F	
Std. 15/16" Lay-in	G1	
Std. 15/16" Tegular	T1	
Std. 15/16" Tegular, against Tee	T1T	
Std. 9/16" Lay-in	G2	
Std. 9/16" Tegular	T2	
Std. 9/16" Tegular, against Tee	T2T	
9/16" Slot-tee Tegular	G3	
Tall 15/16" Lay-in	G4	
Tall 15/16" Tegular	T4	
Tall 15/16" Tegular, against Tee	T4T	
Tall 9/16" Lay-in	G5	
Tall 9/16" Tegular	T5	
Tall 9/16" Tegular, against Tee	T5T	
Node 9/16" Tegular	T6	
Node 9/16" Tegular, against Tee	T6T	
Factory Options		
Chicago Plenum	CP	
Emergency Battery Pack*	EM	
<small>(3' & 4' luminaires only)</small>		
Positional Clips	EQ	
HLR/GLR Fuse	FU	
6' New York City Flex Whip	FNY	
6' Flex Whip	FW	
Include 3000K Lamp*	L830	
Include 3500K Lamp*	L835	
Include 4100K Lamp*	L841	
<small>(Sensor options available—consult factory)</small>		
Finish		WH
Matte White Housing	WH	
Luminaire Length		
2' Nominal Housing	2'	
3' Nominal Housing	3'	
4' Nominal Housing	4'	
5' Nominal Housing	5'	
<small>(For row mount in drywall ceiling, specify luminaire run length, ie 24')</small>		



Avenue® B

FLUORESCENT - FLUSH LENS

FAVB-FL-1T5HO-1C-120-S-G1-WH-4'

Filename: FAVBL1T5.IES
Test #: 16381.0

Lumens: 2220lm
Efficiency: 61%

CANDLEPOWER DISTRIBUTION

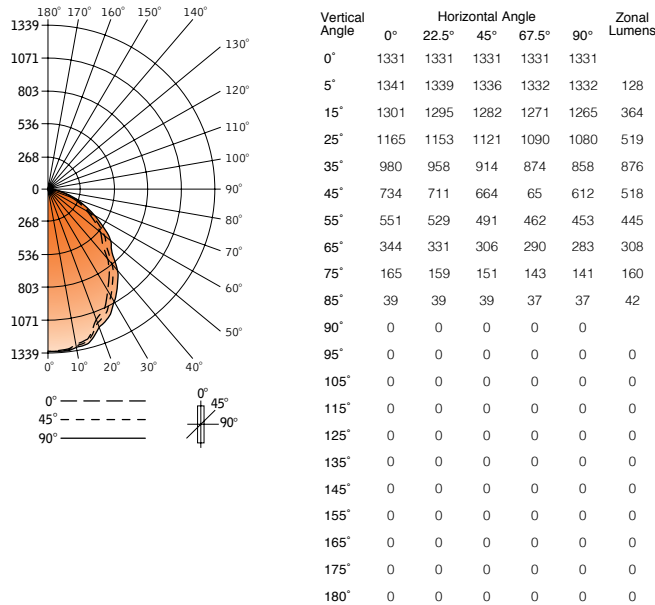

LUMEN SUMMARY

Zone	Lumens	% Lamp	% Fixture
0-30°	1010	20.2	33.0
0-40°	1586	31.7	51.9
0-60°	2548	51.0	83.3
0-90°	3058	61.2	100.0
Total Luminaire	3058	61.2	100.0

LUMINANCE DATA (cd/m²)

Vertical Angle	0°	45°	90°
45°	18298	16553	15256
55°	16933	15090	13922
65°	14348	12763	11804
75°	11238	10284	9603
85°	7888	7888	7483

CO-EFFICIENTS OF UTILIZATION

Floor Ceiling Wall	80				70				20				50				30				10				00			
	70	50	30	10	70	50	10	50	10	50	10	50	10	50	10	50	10	50	10	50	10	50	10					
RCR 0	73	73	73	73	71	71	71	68	68	65	65	62	62	61	61	61	61	61	61	61	61	61	61					
1	68	65	63	61	66	64	60	61	58	59	56	57	54	53	53	53	53	53	53	53	53	53	53					
2	62	58	54	51	61	57	50	55	49	53	48	51	47	46	46	46	46	46	46	46	46	46	46					
3	57	52	47	44	56	51	43	49	43	47	42	46	41	40	40	40	40	40	40	40	40	40	40					
4	53	46	41	38	52	46	38	44	37	43	37	41	36	35	35	35	35	35	35	35	35	35	35					
5	49	41	36	33	47	41	32	39	32	38	32	37	31	30	30	30	30	30	30	30	30	30	30					
6	45	37	32	29	44	37	28	36	28	35	28	34	28	27	27	27	27	27	27	27	27	27	27					
7	42	34	29	25	41	33	25	32	25	31	25	31	25	24	24	24	24	24	24	24	24	24	24					
8	38	30	25	22	37	30	22	29	22	28	22	28	22	21	21	21	21	21	21	21	21	21	21					
9	35	7	23	19	35	27	19	26	19	26	19	26	19	18	18	18	18	18	18	18	18	18	18					
10	33	25	20	17	32	25	17	24	17	24	17	24	17	17	17	17	17	17	17	17	17	17	17					

Numbers indicate percentage values of reflectivity.

Go to www.focalpointlights.com for additional photometric data.

Avenue® B

FLUORESCENT - REGRESS LENS

FAVB-SR-1T5HO-1C-120-S-G1-WH-4'

Filename: FAVBSR1T5HO.IES
Test #: 16377.0

Lumens: 2713lm
Efficiency: 52%

CANDLEPOWER DISTRIBUTION

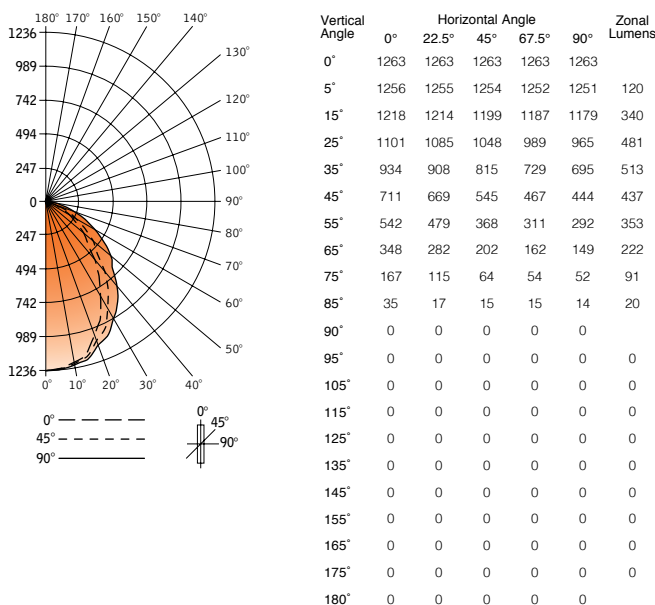

LUMEN SUMMARY

Zone	Lumens	% Lamp	% Fixture
0-30°	941	18.8	36.5
0-40°	1454	29.1	56.4
0-60°	2244	44.9	87.1
0-90°	2576	51.5	100.0
Total Luminaire	2576	51.5	100.0

LUMINANCE DATA (cd/m²)

Vertical Angle	0°	45°	90°
45°	17724	13586	11068
55°	16657	11309	8974
65°	14515	8425	6215
75°	11374	4359	3542
85°	7079	3034	2831

CO-EFFICIENTS OF UTILIZATION

Floor Ceiling Wall	80				70				20				50				30				10				00			
	70	50	30	10	70	50	10	50	10	50	10	50	10	50	10	50	10	50	10	50	10	50	10					
RCR 0	61	61	61	61	60	60	60	57	57	55	55	53	53	52	52	52	52	52	52	52	52	52	52					
1	57	55	53	52	56	54	51	52	49	50	48	48	47	46	46	46	46	46	46	46	46	46	46					
2	53	50	47	44	52	49	44	47	43	45	42	44	41	40	40	40	40	40	40	40	40	40	40					
3	49	45	41	38	48	44	38	42	37	41	37	40	36	35	35	35	35	35	35	35	35	35	35					
4	46	40	36	33	44	40	33	38	33	37	32	36	32	31	31	31	31	31	31	31	31	31	31					
5	42	36	32	29	41	36	29	35	29	34	28	33	28	27	27	27	27	27	27	27	27	27	27					
6	39	33	29	26	38	32	26	31	25	31	25	30	25	24	24	24	24	24	24	24	24	24	24					
7	36	30	26	23	35	9	23	29	22	28	22	27	22	21	21	21	21	21	21	21	21	21	21					
8	33	27	23	20	33	27	20	26	20	25	20	25	20	19	19	19	19	19	19	19	19	19	19					
9	31	24	20	18	30	24	18	23	17	26	17	22	17	17	17	17	17	17	17	17	17	17	17					
10	29	22	18	16	28	22	16	21	16	21	16	20	15	15	15	15	15	15	15	15	15	15	15					

Numbers indicate percentage values of reflectivity.

Go to www.focalpointlights.com for additional photometric data.

Avenue® B

FLUORESCENT - LOUVER

FAVB-PL-1T5HO-1C-120-S-G1-WH-4'

Filename: FAVBPL1T5H.IES
Test #: 16526.0

Lumens: 2727lm
Efficiency: 55%

CANDLEPOWER DISTRIBUTION

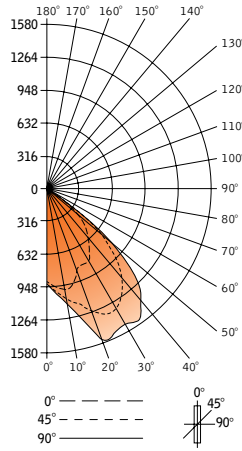

Vertical Angle	Horizontal Angle				Zonal Lumens
	0°	22.5°	45°	67.5°	
0°	953	953	953	953	953
5°	1001	1010	1033	1041	1046
15°	957	1056	1200	1319	1360
25°	840	1023	1381	1557	1583
35°	696	1021	1269	1492	1598
45°	485	715	912	1072	1168
55°	96	158	295	261	215
65°	23	25	28	46	43
75°	7	7	7	10	10
85°	2	2	2	2	2
90°	0	0	0	0	0
95°	0	0	0	0	0
105°	0	0	0	0	0
115°	0	0	0	0	0
125°	0	0	0	0	0
135°	0	0	0	0	0
145°	0	0	0	0	0
155°	0	0	0	0	0
165°	0	0	0	0	0
175°	0	0	0	0	0
180°	0	0	0	0	0

LUMEN SUMMARY

Zone	Lumens	% Lamp	% Fixture
0-30°	1032	20.6	37.8
0-40°	1806	36.1	66.2
0-60°	2684	53.7	98.4
0-90°	2727	54.5	100.0
Total Luminaire	2727	54.5	100.0

LUMINANCE DATA (cd/m²)

Vertical Angle	0°	45°	90°
45°	9174	17251	22093
55°	2239	6879	5013
65°	728	886	1361
75°	362	362	517
85°	307	307	307

CO-EFFICIENTS OF UTILIZATION

Floor Ceiling Wall	80				70			20 50		30		10		00
	70	50	30	10	70	50	10	50	10	50	10	50	10	00
RCR 0	65	65	65	65	63	63	63	61	61	58	58	56	56	55
1	61	60	58	56	60	58	56	56	54	54	52	52	51	50
2	58	55	52	50	56	54	49	52	48	50	47	49	46	45
3	54	50	47	44	53	49	44	48	43	46	42	45	42	41
4	50	45	42	39	49	45	39	43	38	42	38	41	37	36
5	47	41	37	34	46	41	34	40	34	39	34	38	33	32
6	43	38	34	31	43	37	31	36	30	35	30	35	30	29
7	40	34	30	27	39	34	27	33	27	32	27	31	26	26
8	37	30	26	24	36	30	24	29	23	29	23	28	23	22
9	34	27	23	20	33	27	20	26	20	26	20	25	20	19
10	31	25	21	18	31	24	18	24	18	23	18	23	18	17

Numbers indicate percentage values of reflectivity.

Go to www.focalpointlights.com for additional photometric data.

Avenue® B

FLUORESCENT & LED GRID CEILING CONFIGURATIONS



Avenue B is configured at our factory to integrate easily with your specified grid type, tile style and fixture position. Please review the below options and choose the mounting code that matches your application.

