

Equation™ 2 2x2

LED



opal acrylic lens



MicroGlow lens

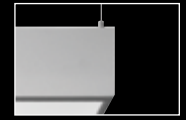

suspended or surface mount

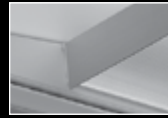

air return

DIMENSIONAL DATA

Overall height of luminaire with air return is 4.60"

led options

Standard High Efficiency

1 LED board 2 LED boards

FEATURES

- Equation™ 2 blends sleek aesthetics with uniform diffuse illumination.
- Center diffuser features MicroGlow prismatic lens for brightness control and visual comfort. Opal acrylic center lens may also be specified.
- Premium LEDs operate efficiently to achieve excellent thermal management and reliable operation.
- Connected Solutions: Integrates with wired and wireless building lighting control systems.

PERFORMANCE

PRODUCT OVERVIEW

Lumen Output: 2000-5000lm
 Wattage: 21-54W
 LPW: 83-103
 SDCM: 3

Opal Acrylic Lens
Delivered Lumens: 3500lm
Total System Watts: 35W

Photometric performance is measured in accordance with IESNA LM-79. Visit focalpointlights.com for complete photometric data. Visit designlights.org/QPL for model specifics.

MOUNTING INFORMATION

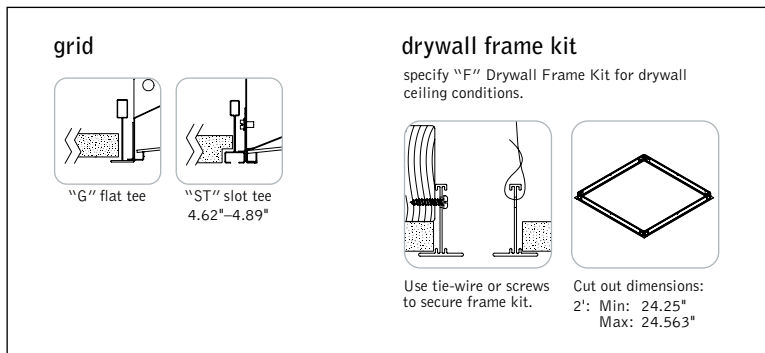

SPECIFICATIONS

LED System

Proprietary linear LED module incorporates premium LEDs on a robust platform to achieve excellent thermal management. LEDs are placed to promote a uniform appearance. Available in 3000K, 3000K or 4000K with CRI>80, 3 SDCM. Contact factory for additional color temperature and CRI options. 0-10V dimming driver standard. LED modules and drivers are replaceable from below.

Construction

One-piece 24 Ga. steel reflector and housing. Bottom access 24 Ga. steel driver compartment. Positional brackets supplied as standard. Standard weight: 15.4 lbs. Surface-mount/suspended weight: 19 lbs.

Optic

24 Ga. steel reflectors finished in matte satin white powder coat. .080" thick frosted white acrylic diffusers. Center shielding options include .080" thick opal acrylic lens or MicroGlow prismatic lens with optical filter overlay.

Electrical

Standard 120-277V driver includes 0-10V analog dimming. Power factor > .9. Optional DALI, Lutron EcoSystem or Step-dimming drivers available.

Emergency Battery

Bodine BSL310-CAN. Emergency output—10 watts for 90 minutes.

Labels

UL and cUL listed. Suitable for Dry or Damp Locations, indoor use only.

Finish

Polyester powder coat applied over a multi-stage pre-treatment.

Lumen Maintenance

Reported: L70 at >60,000 hours Calculated: L70 at 135,000 hours
L80 at >60,000 hours L80 at 80,000 hours
Derived from EPA TM-21 calculator. Based on typical conditions, consult factory for additional data.

Reliability

At Focal Point, our products are designed to stand the test of time. Each luminaire is engineered using superior components, manufactured with the utmost care and rigorously tested. Contact us for reliability data.

Warranty

LED system rated for operation in ambient environments up to 25°C. 5-year limited warranty.

PERFORMANCE CHART

Delivered Lumens		Tested System Watts	LPW
2000 Lumens	2000L	21	96
	2500L	28	92
2500 Lumens	2500LH	25	103
	3000L	35	88
3000 Lumens	3000LH	30	101
	3500L	42	83
3500 Lumens	3500LH	35	100
	4000L	41	97
4500 Lumens	4500LH	47	94
5000 Lumens	5000LH	54	90

*Lumen output may vary +/- 5%. Actual wattage may vary +/- 5%. Multipliers: 2700K - 0.949, 3000K - 0.966, 4000K - 1.025.

ORDERING

Luminaire Series	FEQ2
Equation 2	FEQ2
Nominal Size	22
2' x 2'	22
Shielding	
Opal Acrylic Lens	AC
MicroGlow Prismatic Lens	MG
Lumen Output	
Standard	
2000 Lumens	2000L
2500 Lumens	2500L
3000 Lumens	3000L
3500 Lumens	3500L
High Efficiency	
2500 Lumens	2500LH
3000 Lumens	3000LH
3500 Lumens	3500LH
4000 Lumens	4000LH
4500 Lumens	4500LH
5000 Lumens	5000LH
Color Temperature	
3000K	30K
3500K	35K
4000K	40K
Circuit	1C
Single Circuit	1C
Voltage	
UNV 120/277 Volt	UNV
347 Volt	347
<small>(Not available with SD5, CLM1, DLM1, ENL1 or NLT1. Transformer required for all drivers except LD1.)</small>	
Control System & Dimming Level	
0-10V - 10% Dimming	LD1
0-10V - 1% Dimming	L11
Lutron Hi-Lume EcoSystem (LDE1) - 1% Dimming	LH1
Lutron 5-Series EcoSystem (LDE5) - 5% Dimming	LU5
DALI - 1% Dimming	D11
<small>(2000L, 2500L, 2500LH & 3000LH only.)</small>	
Step Dimming	SD5
<small>(Not available with 2500LH, 120/277 only.)</small>	
Acuity nLight - 1% Dimming	NLT1
<small>(Not available with EM or CP. 2000L, 2500L, 2500LH & 3000LH only.)</small>	
Enlighted Smart Sensor - 1% Dimming	ENL1
Osram Connected Lighting Module - 1% Dimming	CLM1
<small>(Compatible with Daintree Networks & Osram ENCELUM and Simplux systems. Not available with EM.)</small>	
Wattstopper DLM - 1% Dimming	DLM1
<small>(Not available with EM.)</small>	
Mounting	
24" Aircraft Cable	C24
48" Aircraft Cable	C48
96" Aircraft Cable	C96
Drywall Frame Kit	F
<small>(NLT1, ENL1, CLM1 & DLM1 not available)</small>	
<small>(Cut out dimensions: Min: 24.25"/Max: 24.563")</small>	
Grid	G
Slot Tee	ST
Surface Mount	SM
<small>(NLT1 & DLM1 not available)</small>	
Factory Options	
Air Return	AR
<small>(Overall height with Air Return is 4.62"-4.89")</small>	
Chicago Plenum	CP
Emergency Battery Pack with Integral Test Switch	EM
<small>(Cannot combine 347V and EM with L11, D11 or Lutron driver.)</small>	
6' New York City Flex Whip (120V)	FNY1
6' New York City Flex Whip (277V)	FNY2
6' Flex Whip	FW
Finish	WH
Matte Satin White	WH



Options in orange qualify for the Quickship program. 5-day up to 100 pieces, 10-day up to 300 pieces. Refer to Quickship Guide for complete details.

Focal Point provides flexibility in meeting the needs of each project by integrating with several building lighting control systems. A variety of sensors, drivers and other components can be specified that allow the luminaires to communicate with wired and wireless networks. All zoning can be digitally reconfigured through the application software. Daylight harvesting, occupancy sensing, integration with HVAC systems, and individual controls enable the monitoring and modulating of light levels and temperature in order to save energy, reduce costs and maximize occupants' comfort.

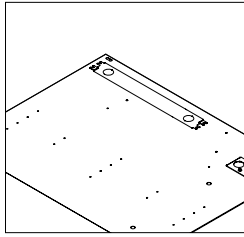

nLight® provides a two-way wired digital lighting system allowing for on/off and dimming functionality, occupancy sensing, and multi-zone daylight harvesting.

Acuity nLight - 1% Dimming (NLT1)
Acuity Model #nEPS-60-IO

CAT-5 Cable provided by others. Serial labels will be provided on outside of luminaires and control unit.



Enlighted smart sensor allows for occupancy sensing, daylight harvesting, energy usage, temperature and light level control. Communicates wirelessly with the Enlighted network.

Enlighted Smart Sensor - 1% Dimming (ENL1)
Enlighted Model #SU-4E-01



Connected Lighting Module (CLM) enables each luminaire to be independently controlled and configured. Communicates wirelessly with Daintree Networks®, Osram ENCELIUM®, Osram Simplux™ and other networks using the ZigBee® HA communication protocol to allow for on/off and dimming functionality, occupancy sensing and multi-zone daylight harvesting.

Osram CLM - 1% Dimming (CLM1)
Osram Model #ZBHA-CLM DIM

Serial labels will be provided on outside of luminaires and control unit.

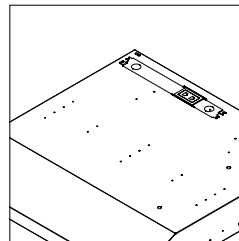

A Digital Lighting Management (DLM) system that provides two-way wired communication between networked luminaires and control system to allow for on/off and dimming functionality, occupancy sensing and multi-zone daylight harvesting.

Wattstopper DLM - 1% Dimming (DLM1)
Wattstopper Model #LMFC-011

CAT-5 Cable provided by others. Serial labels will be provided on outside of luminaires and control unit.

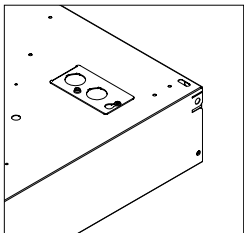

A two-way digital network that enables on/off and dimming functionality, occupancy sensing, and multi-zone daylight harvesting working with Quantum®, Energi Savr Node™, and Energi TriPak® using EcoSystem® communication protocol.

Lutron Hi-Lume EcoSystem - 1% Dimming (LH1)
Lutron Model #LDE1

Lutron 5-Series EcoSystem - 5% Dimming (LU5)
Lutron Model #LDE5

CONNECTED SOLUTIONS DETAILS

Connected Solution	Model #	Protocol	Compatible Networks*	Occupancy	Daylight	Temperature Reporting	Communication to Luminaire	Drivers
Acuity nLight (NLT1)	nEPS-60-IO**	nLight	nLight	Enabled	Enabled	No	Wired	eldoLED ECOdrive , eldoLED SOLOdrive
Enlighted Smart Sensor (ENL1)	SU-4E-01**	Enlighted RF	Enlighted	Integrated	Integrated	Yes	Wireless	Osram Optotronic , Philips SimpleSet
Legrand Wattstopper DLM (DLM1)	LMFC-011**	DLM	DLM	Enabled	Enabled	No	Wired	Osram Optotronic , Philips SimpleSet
Lutron EcoSystem (LH1 & LU5)	LDE1,** LDE5**	EcoSystem	Quantum, Energi Savr Node, Energi TriPak	Enabled	Enabled	No	Wired	Lutron Hi-Lume Lutron 5-Series
Osram CLM (CLM1)	ZBHA-CLM**	ZigBee HA	Osram ENCELIUM & Simplux, Daintree Networks	Enabled	Enabled	No	Wireless	Osram Optotronic

*Not all compatible networks may be listed. **For performance data and additional control system details please visit the connected solutions manufacturer websites. Primary drivers are listed in bold. To specify a particular driver please consult factory.

Equation™ 2 2x2

LED

FEQ2-22-AC-3500LLH-35K-1C-UNV-LD1

Filename: FEQ222AC3500LLH35K.IES
 Test #: 1246031 extrapolated

Lumens: 3493lm
 System Watts: 35W
 LPW: 100

CANDLEPOWER DISTRIBUTION

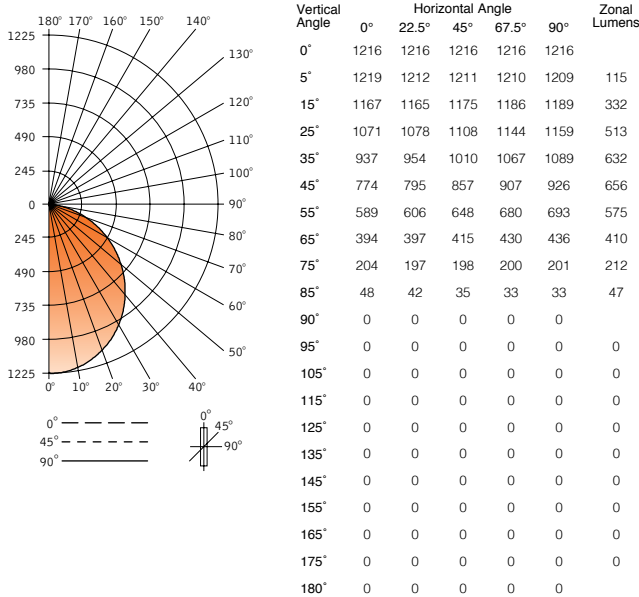

LUMEN SUMMARY

Zone	Lumens	% Fixture
0-30°	960	27.5
0-40°	1592	45.6
0-60°	2823	80.8
0-90°	3493	100.0
Total Luminaire 0-180°	3493	100.0

LUMINANCE DATA (CD/M²)

Vertical Angle	0°	45°	90°
45°	3274	3627	3917
55°	3074	3382	3615
65°	2788	2939	3084
75°	2354	2286	2326
85°	1639	1208	1134

CO-EFFICIENTS OF UTILIZATION

Floor Ceiling Wall	80				70			20 50		30		10		00
	70	50	30	10	70	50	10	50	10	50	10	50	10	00
RCR 0	119	119	119	119	116	116	116	111	111	106	106	102	102	100
1	109	104	100	97	106	102	95	98	92	94	89	90	87	84
2	99	91	85	79	97	89	78	86	76	83	74	79	73	71
3	91	80	72	66	88	79	65	76	64	73	63	70	62	60
4	83	71	62	56	81	70	55	67	54	65	54	63	53	51
5	76	63	54	48	74	62	48	60	47	58	47	56	46	44
6	70	57	48	42	68	56	42	54	41	53	41	51	40	38
7	65	52	43	37	63	51	37	49	36	48	36	47	36	34
8	61	47	39	33	59	46	33	45	32	44	32	43	32	30
9	57	43	35	29	55	43	29	41	29	40	29	39	29	27
10	53	40	32	27	52	39	27	38	26	37	26	37	26	24

Numbers indicate percentage values of reflectivity.

Go to www.focalpointlights.com for additional photometric data.

Equation™ 2 2x2

LED

FEQ2-22-MG-3500LH-35K-1C-UNV-LD1

Filename: FEQ222MG3500LH35K.IES
 Test #: 1237068 extrapolated

Lumens: 3425lm
 System Watts: 35W
 LPW: 98

CANDLEPOWER DISTRIBUTION

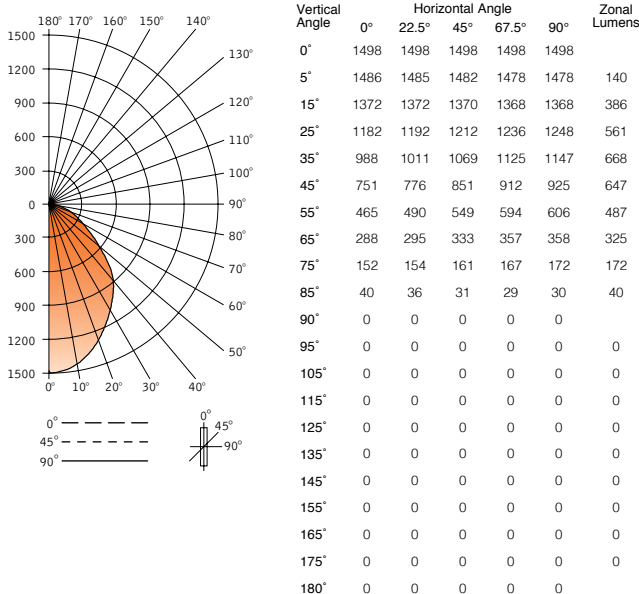

LUMEN SUMMARY

Zone	Lumens	% Fixture
0-30°	1086	31.7
0-40°	1735	51.2
0-60°	2888	84.3
0-90°	3425	100.0
Total Luminaire 0-180°	3425	100.0

LUMINANCE DATA (CD/M²)

Vertical Angle	0°	45°	90°
45°	3178	3602	3913
55°	2427	2864	3161
65°	2037	2357	2531
75°	1761	1866	1990
85°	1365	1051	1015

CO-EFFICIENTS OF UTILIZATION

Floor Ceiling Wall	80				70			20 50		30		10		00
	70	50	30	10	70	50	10	50	10	50	10	50	10	00
RCR 0	119	119	119	119	116	116	116	111	111	106	106	102	102	100
1	110	105	101	98	107	103	96	99	93	95	90	91	88	86
2	101	93	87	81	98	91	80	88	78	84	77	81	75	73
3	92	82	75	69	90	81	68	78	67	75	66	73	65	62
4	85	74	65	59	83	72	59	70	58	67	57	65	56	54
5	78	66	58	51	76	65	51	63	50	61	50	59	49	47
6	73	60	51	45	71	59	45	57	45	55	44	54	44	42
7	67	54	46	40	66	54	40	52	40	51	39	49	39	37
8	63	50	41	36	61	49	36	48	36	47	36	46	35	33
9	59	46	38	33	57	45	33	44	32	43	32	42	32	30
10	55	42	35	30	54	42	30	41	29	40	29	39	29	28

Numbers indicate percentage values of reflectivity.

Go to www.focalpointlights.com for additional photometric data.