

ID+ 3.5" Trimless

LED WALL WASH



FOCAL POINT®



clear diffuse



warm diffuse



black painted



white painted



overlap companion

DIMENSIONAL DATA

60° cut-off reflector

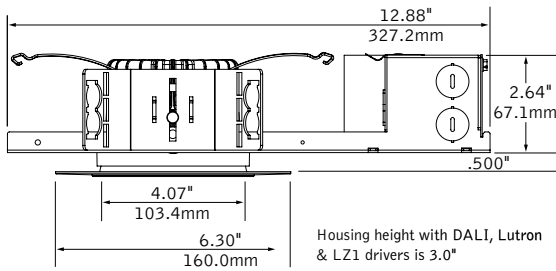

50° cut-off reflector

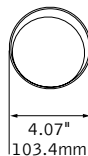
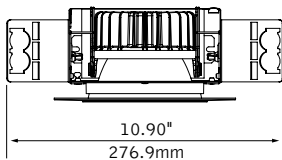
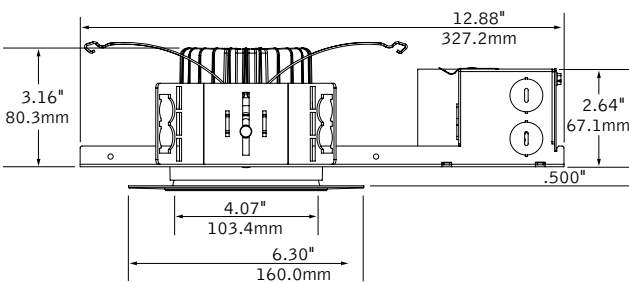

FEATURES

Less than 2.64" low profile housing available.

ChromaSure: Color consistency resulting in a 2-step MacAdam ellipse across the entire ID+ product line.

Field adjustability of ceiling thickness from 0.5" - 1.5".

50° cut-off and 60° cut-off reflector options available.

Selection of dimming drivers available.

PERFORMANCE

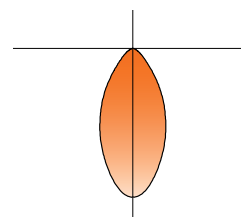

Short 60° Cut-off,
White Reflector, 3500K
Delivered Lumens: 1500lm
Total System Watts: 19W

PRODUCT OVERVIEW

Lumen Output:	700-1500lm
Wattage:	8-19W
LPW:	78-86
SDCM:	2

Photometric performance is measured in accordance with IESNA LM-79. Visit focalpointlights.com for complete photometric data. Visit energystar.gov for model specifics.

fixture:

project:

HOUSING DETAILS

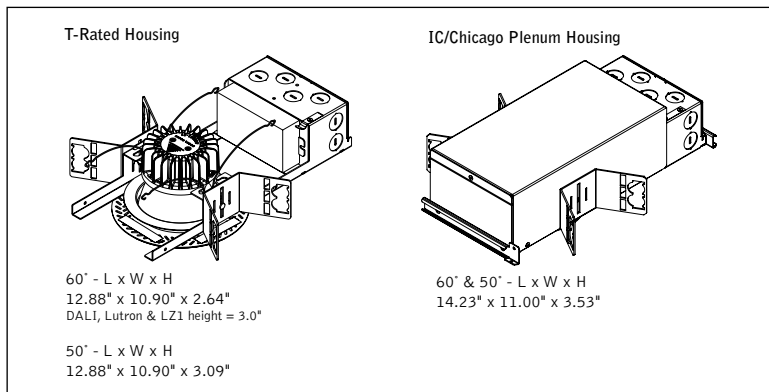

HOUSING SPECIFICATIONS

Construction

Thermally protected housing for new construction applications. Insulation to be kept 3" away from housing. Type IC inherently protected, suitable for direct contact with insulation. Restrictive airflow per ASTM-E283. Butterfly brackets allow mounting to ½ emt. Order bar hangers as an accessory. Die-cast aluminum heat sink designed for maximum thermal dissipation. Die-formed housing and integral junction box with (7) 1/2" pry outs. Accommodates ceiling thicknesses up to 0.5" standard, field adjustable up to 1.5" thickness. For thicker ceiling consult factory. Fixture will not exceed 5 lb.

Electrical

Choice of constant current dimming drivers. Power factor > .9 typical.

Labels

UL and cUL listed. Suitable for Dry, Damp or Wet Locations, indoor use only.

Lumen Maintenance

Reported: L70 at >55,000 hours Calculated: L70 at 420,000 hours
 L90 at >55,000 hours L90 at 109,000 hours

Derived from EPA TM-21 calculator. Based on typical conditions, consult factory for additional data.

Reliability

At Focal Point, our products are designed to stand the test of time. Each luminaire is engineered using superior components, manufactured with the utmost care and rigorously tested. Contact us for reliability data.

Warranty

LED System rated for operation in ambient environments up to 25°C. 5-year limited warranty.

TRIM & LED SPECIFICATIONS

LED System

Proprietary array incorporates premium LEDs on a robust platform. May be specified in 2700K, 3000K, 3500K or 4000K, CRI>80 or >90. Color accuracy within 2 SDCM. Aluminum heat sink provides appropriate thermal management.

Aesthetics

Parabolic reflector cone ensures glare free optics. Reflector is .050 spun aluminum.

Optics

50-degree or 60-degree cut-off to light source and its image. Wall wash features acrylic diffuser to provide smooth illumination down the wall.

PERFORMANCE CHART—SHORT 60° CUT-OFF

Delivered Lumens	System Watts	LPW
700	8	83
900	10	86
1100	13	87
1300	16	81
1500	19	78

Based on Trimless, 3500K, 80CRI, Wide Flood, Clear Diffuse. See page 3 for lumen performance multipliers. Lumen output may vary +/- 5%. Actual wattage may vary +/- 5%.

HOUSING ORDERING

Housing Series	FLC3W
ID+ 3.5" Round	FLC3W
Trim Type	RT
Round Trimless	RT
Lumen Output	
700 Lumen	700L
900 Lumen	900L
1100 Lumen	1100L
1300 Lumen	1300L
1500 Lumen	1500L
Voltage	
120V	120
277V	277
Control System & Dimming Level	
0-10V - 0% Dimming	LZ1
0-10V - 1% Dimming	L11
0-10V - 10% Dimming	LD1
Forward Phase	LFP
<small>(120V only. 900 & 1300 Lumens only.)</small>	
Lutron Hi-Lume EcoSystem (LDE1) -	
1% Dimming	LH1
<small>(700 & 1500 lumens not available.)</small>	
Lutron 5-Series EcoSystem (LDE5) -	
5% Dimming	LU5
<small>(1300 Lumens only)</small>	
Lutron Hi-Lume - Forward Phase -	
1% Dimming	LTE
<small>(120V only. 1500 lumens not available.)</small>	
DALI - 0% Dimming	DZ1
DALI - 1% Dimming	D11
Housing Type	
IC Rated / Airtight	IC
<small>(Available options: L11 & LD1: 700, 900 & 1100 Lumens. LFP: 900 & 1300 Lumens.)</small>	
Thermally Protected, Non-IC	T
<small>(Housing height = 3.0" for LZ1, L3D, LH1, LTE, LU5, D11 & DZ1)</small>	
Factory Options	
Bar Hangers	BH
Chicago Plenum	CP
TRIM & LED MODULE	
Aperture	LC3
3.5" Round Reflector	LC3
Trim Type	RT
Round Trimless	RT
Lumen Output	
<small>(Trim & housing output must match)</small>	
700 Lumen	700L
900 Lumen	900L
1100 Lumen	1100L
1300 Lumen	1300L
1500 Lumen	1500L
Color Temperature	
2700K, 80+ CRI	27K
2700K, 90+ CRI	927K
3000K, 80+ CRI	30K
3000K, 90+ CRI	930K
3500K, 80+ CRI	35K
3500K, 90+ CRI	935K
4000K, 80+ CRI	40K
4000K, 90+ CRI	940K
Optic	
Tall Cone with 50° cut-off	WWT
Short Cone with 60° cut-off	WWS
Color	
Clear Diffuse	CD
Warm Diffuse	WD
Black	BK
White	WH
ACCESSORIES	
Wood Ceiling Installation Kit	LC3-WOOD-KIT
<small>(One kit recommended per 10 downlights)</small>	



Options in orange qualify for the Quickship program. 5-day up to 100 pieces. Refer to Quickship Guide for complete details.

LUMEN PERFORMANCE MULTIPLIER CHART - ROUND WALL WASH

Option	Description	Ordering Code	Multiplier
Trim Type	Round Trimless	RT	0.92
	Round Overlap	RO	0.89
Color Temperature	2700K, 80+ CRI	27K	0.93
	2700K, 90+ CRI	927K	0.75
	3000K, 80+ CRI	30K	1.00
	3000K, 90+ CRI	930K	0.81
	3500K, 80+ CRI	35K	1.00
	3500K, 90+ CRI	935K	0.87
	4000K, 80+ CRI	40K	1.00
	4000K, 90+ CRI	940K	0.87
Optic	Tall Cone with 50° cut-off	WWT	0.99
	Short Cone with 60° cut-off	WWS	1.00
Color	Clear Diffuse	CD	1.00
	Warm Diffuse	WD	0.94
	White	WH	1.13
	Black	BK	0.56

ID+ 3.5"

LED WALL WASH

FLC3W-RT-1300L-120-L11-T/LC3-RT-1300L-35K-WWS-WH

Filename: FLC3WRT1300LRT35KWWSWH.IES

Lumens: 1400lm

System Watts: 16W

LPW: 88

CANDLEPOWER DISTRIBUTION

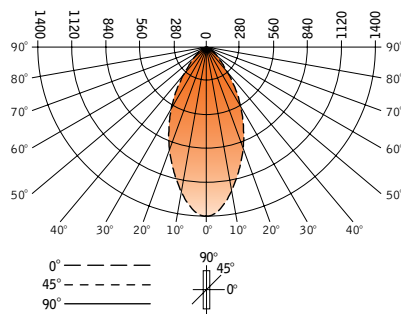

Vertical Angle	Horizontal Angle				Zonal Lumens
	0°	22.5°	45°	67.5°	
0°	1267	1267	1267	1267	1267
5°	1248	1237	1229	1222	1218
15°	1077	1042	1002	968	953
25°	863	811	746	687	660
35°	623	569	491	416	383
45°	399	348	269	195	166
55°	203	176	133	97	78
65°	101	91	71	48	32
75°	52	45	33	18	9
85°	19	15	8	2	0
90°	3	1	0	0	0

LUMEN SUMMARY

Zone	Lumens	% Fixture
0-30°	732	52.3
0-40°	1031	73.7
0-60°	1332	95.2
0-90°	1400	100.0
Total Luminaire	0-180°	1400 100.0

LUMINANCE DATA (CD/M²)

Vertical Angle	Horizontal		
	0°	45°	90°
45°	78866	53087	32890
55°	49410	32409	19078
65°	33399	23533	10587
75°	27830	17768	4656
85°	30832	12237	476

CO-EFFICIENTS OF UTILIZATION

Floor Ceiling Wall	80				70				50				30				10				00			
	70	50	30	10	70	50	30	10	50	10	50	10	50	10	50	10	50	10	50	10	50	10	50	10
RCR 0	119	119	119	119	116	116	116	111	111	106	106	102	102	102	102	100	100	100	100	100	100	100	100	
1	112	109	106	103	110	107	101	102	98	99	95	95	93	91	91	91	91	91	91	91	91	91	91	
2	105	99	94	90	103	97	89	94	87	91	85	88	83	82	82	82	82	82	82	82	82	82	82	
3	98	91	85	80	96	89	79	86	78	84	77	82	75	74	74	74	74	74	74	74	74	74	74	
4	92	83	76	71	90	82	71	80	70	78	69	76	68	67	67	67	67	67	67	67	67	67	67	
5	87	77	70	64	85	76	64	74	64	72	63	70	62	61	61	61	61	61	61	61	61	61	61	
6	81	71	64	59	80	70	58	68	58	67	58	65	57	55	55	55	55	55	55	55	55	55	55	
7	77	66	59	54	75	65	54	64	53	62	53	61	53	51	51	51	51	51	51	51	51	51	51	
8	72	61	54	49	71	61	49	59	49	58	49	57	49	47	47	47	47	47	47	47	47	47	47	
9	68	57	50	46	67	57	46	56	46	55	45	54	45	44	44	44	44	44	44	44	44	44	44	
10	65	54	47	43	64	53	43	52	42	51	42	51	42	41	41	41	41	41	41	41	41	41	41	

Go to www.focalpointlights.com for additional photometric data.

Numbers indicate percentage values of reflectivity.

ID+ 3.5"

LED WALL WASH

FLC3W-RT-1300L-120-L11-T/LC3-RT-1300L-35K-WWT-CD

Filename: FLC3WRT1300LRT35KWWTCD.IES

Lumens: 1263lm

System Watts: 14W

LPW: 88

CANDLEPOWER DISTRIBUTION

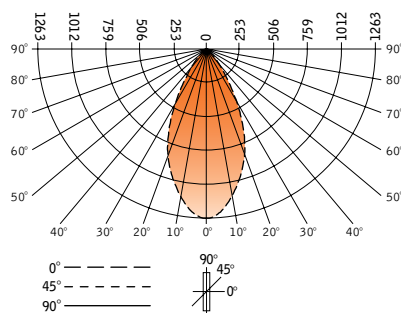

Vertical Angle	Horizontal Angle				Zonal Lumens
	0°	22.5°	45°	67.5°	
0°	1679	1679	1679	1679	1679
5°	1623	1623	1623	1623	1623
15°	1307	1307	1307	1307	1307
25°	871	871	871	871	871
35°	367	367	367	367	367
45°	117	117	117	117	117
55°	18	18	18	18	18
65°	4	4	4	4	4
75°	1	1	1	1	1
85°	0	0	0	0	0
90°	0	0	0	0	0

LUMEN SUMMARY

Zone	Lumens	% Fixture
0-30°	908	71.9
0-40°	1143	90.6
0-60°	1256	99.5
0-90°	1263	100.00
Total Luminaire	0-180°	1263 100.00

LUMINANCE DATA (CD/M²)

Vertical Angle	Horizontal		
	0°	45°	90°
45°	20357	20357	20357
55°	3833	3833	3833
65°	1230	1230	1230
75°	628	628	628
85°	373	373	373

CO-EFFICIENTS OF UTILIZATION

Floor Ceiling Wall	80				70				50				30				10				00			
	70	50	30	10	70	50	30	10	50	10	50	10	50	10	50	10	50	10	50	10	50	10	50	10
RCR 0	114	111	108	106	111	109	104	105	101	101	98	97	95	94	94	94	94	94	94	94	94	94	94	94
1	108	103	99	96	106	101	95	98	93	95	91	92	89	87	87	87	87	87	87	87	87	87	87	87
2	103	96	91	87	101	95	87	92	85	90	84	88	83	81	81	81	81	81	81	81	81	81	81	81
3	97	90	84	80	96	89	80	87	79	85	78	83	77	76	76	76	76	76	76	76	76	76	76	76
4	93	84	79	74	91	83	74	82	73	80	73	78	72	71	71	71	71	71	71	71	71	71	71	71
5	88	79	73	69	87	78	69	77	68	75	68	74	67	66	66	66	66	66	66	66	66	66	66	66
6	84	75	69	64	82	74	64	73	64	71	64	70	63	62	62	62	62	62	62	62	62	62	62	62
7	80	70	64	60	79	70	60	69	60	68	60	67	59	58	58	58	58	58	58	58	58	58	58	58
8	76	67	61	57	75	66	57	65	56	64	56	63	56	55	55	55	55	55	55	55	55	55	55	55
9	73	63	57	53	72	63	53	62	53	61	53	60	53	52	52	52	52	52	52	52	52	52	52	52

Go to www.focalpointlights.com for additional photometric data.

Numbers indicate percentage values of reflectivity.