

end detail

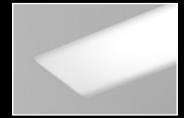

corner detail



recessed companion



wall to ceiling companion

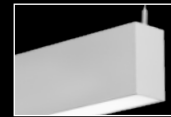

suspended companion

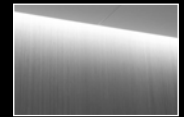

perimeter companion

DIMENSIONAL DATA

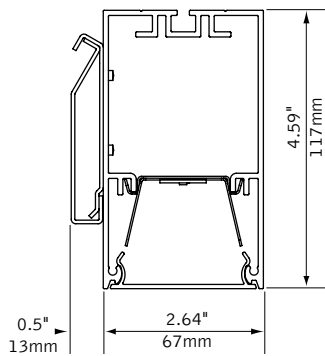

note: requires 4"x2" handy box.

FEATURES

Narrow extruded aluminum 2.5" wall mount direct LED.

Individual units and continuous runs in 1' increments.

Frosted acrylic lens provides uninterrupted illumination, without pixels or shadows.

LED position and lens material optimized to provide the perfect blend of high performance and visual comfort.

Choice of output levels to meet a wide variety of application needs.

PERFORMANCE

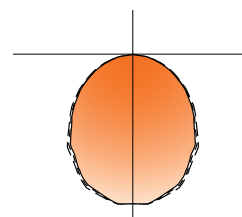

4' Flush Lens
Nominal output:
250 Lumens per foot

Delivered Lumens: 1000lm
Total System Watts: 13W

PRODUCT OVERVIEW

Lumen Output: 500-2500lm
Wattage: 5-33W
LPW: 76-96
SDCM: 3
Reported Lumen L70 @
Maintenance: >60,000hrs

Photometric performance is measured in accordance with IESNA LM-79.
Visit focalpointlights.com for complete photometric data.

fixture:

project:

MOUNTING INFORMATION

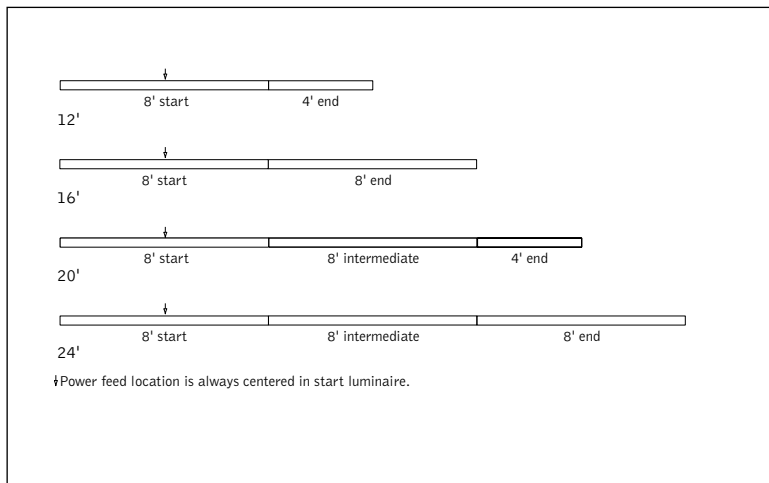

SPECIFICATIONS

LED System

Proprietary linear LED module incorporates premium LEDs on a robust platform to achieve excellent thermal management. LEDs are placed to promote a uniform appearance. Available in 3000K, 3500K or 4000K with CRI>80, 3SDCM. LED modules and drivers are replaceable from below.

Construction

One piece extruded aluminum housing. Cast aluminum end caps. 2' unit weight: 4.8 lbs., 3' unit weight: 7.2 lbs., 4' unit weight: 9.6 lbs., 5' unit weight: 12 lbs.

Optic

Reflectors fabricated of 22 Ga. steel finished in High Reflectance White powder coat. Extruded acrylic lens .07" thick with satin finish, up to 8' continuous.

Electrical

Luminaires are pre-wired with factory installed branch circuit wiring and over-molded quick connects. Standard 120-277V constant current driver includes 0-10V analog dimming. Power factor > .9.

Emergency Battery

IOTA CP-10. Emergency output - 10 watts for 90 minutes.

Labels

UL and cUL listed. Suitable for Dry or Damp Locations, indoor use only.

Finish

Polyester powder coat applied over a 5-stage pre-treatment.

Lumen Maintenance

Calculated: L70 at 77,000 hours Reported: L70 at >60,000 hours
 Derived from EPA TM-21 calculator based on 10,000 hours of test data.

Warranty

LED system rated for operation in ambient environments up to 25°C. 5 year limited warranty.

4' PERFORMANCE CHART

Shielding	Lumens per Foot	Delivered Lumens	Tested System Watts	LPW
Flush Lens	125LF	500	5	96
	250LF	1000	13	80
	375LF	1500	19	79
	625LF	2500	33	76

*Based on 3500k, 4' lengths. *Lumen output may vary +/- 5%. Actual wattage may vary +/- 5%

ORDERING

Luminaire Series	Seem 2 LED	FSM2LW	FSM2LW
Shielding	Flush Satin Lens	FL	FL
Lumen Output	125 Lumens per foot <small>(LD1, L11 & D11 only. 4' minimum.)</small>	125LF	
	250 Lumens per foot <small>(Not available with LU5 & LH1. 4' minimum with D11)</small>	250LF	
	375 Lumens per foot <small>(4' minimum with LU5, LH1 & D11)</small>	375LF	
	625 Lumens per foot <small>(3' minimum with LU5 & LH1 Drivers)</small>	625LF	
Color Temperature	3000K	30K	
	3500K	35K	
	4000K	40K	
Circuit	Single Circuit	1C	1C
Voltage	120 Volt	120	
	277 Volt	277	
	UNV Volt	UNV	
<small>(Cannot be specified with EM option)</small>			
Driver	<small>(See driver reference for driver quantities)</small>		
	0-10V - 10% Dimming	LD1	
	0-10V - 1% Dimming	L11	
	Lutron A-Series	L3D	
	1% EcoSystem Digital <small>(Consult factory for 3-wire control)</small>		
	Lutron H-Series 1% Dimming	LH1	
	Lutron 5-Series	LU5	
	5% EcoSystem Digital		
	DALI 1% Dimming	D11	
Mounting	Wall Mount	WM	WM
Factory Options	Emergency Circuit*	EC	
	Emergency Battery Pack*	EM	
Finish	Titanium Silver	TS	
	Matte White Housing	WH	
Luminaire Length	Specify luminaire/row length in 1' increments <small>(Smaller increments available. Consult factory for details.)</small>	XX'	
Pattern Options	<small>(3' minimum length)</small> 'L' pattern <small>(Consult factory for other pattern options)</small>	A' x B'	

Seem[®] 2

LED - FLUSH LENS

FSM2L-FL-250LF-35K-1C-120-LD1-G1-WH-4

Lumens: 1155lm

Filename: FSM2LFL250LF35K.IES

System Watts: 13W

Test #: 11482956.01

LPW: 85

CANDLEPOWER DISTRIBUTION

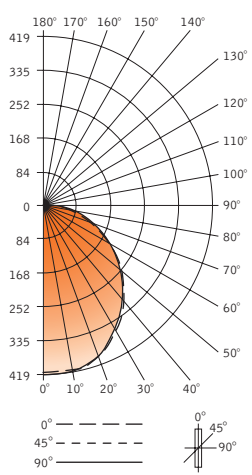

Vertical Angle	Horizontal Angle				
	0°	22.5°	45°	67.5°	90°
0°	419	419	419	419	419
5°	416	420	417	417	417
15°	399	403	400	400	400
25°	367	369	365	364	364
35°	319	321	317	316	315
45°	262	264	261	260	259
55°	203	204	201	201	201
65°	140	142	141	141	141
75°	79	81	81	81	82
85°	25	25	25	25	26
90°	1	3	3	3	3
95°	0	0	0	0	0
105°	0	0	0	0	0
115°	0	0	0	0	0
125°	0	0	0	0	0
135°	0	0	0	0	0
145°	0	0	0	0	0
155°	0	0	0	0	0
165°	0	0	0	0	0
175°	0	0	0	0	0
180°	0	0	0	0	0

LUMEN SUMMARY

Zone	Lumens	% Fixture
0-40°	520	45.0
0-60°	902	78.1
0-90°	1155	100.0
Total Luminaire 0-180°	1155	100.0

LUMINANCE DATA (CD/M²)

Vertical Angle	Horizontal		
	0°	45°	90°
45°	4895	4867	4837
55°	4658	4637	4622
65°	4373	4397	4400
75°	4044	4108	4156
85°	3776	3794	3860

Go to www.focalpointlights.com for additional photometric data.