

recessed
companion

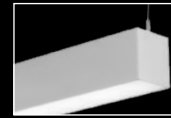

suspended
companion

DIMENSIONAL DATA

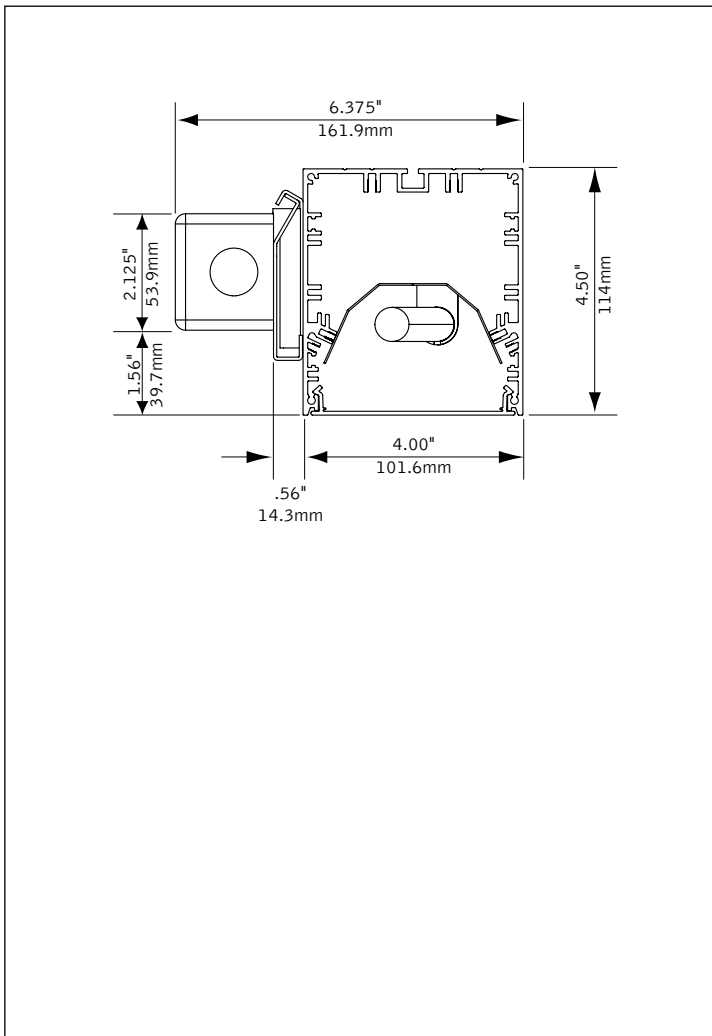

FEATURES

Narrow 4" fluorescent wall mount allows for both individual or continuous row mount.

Frosted acrylic flush lens provides even illumination, high performance lens available for increased efficiency.

Available in T5, T5HO or T8, Seem 4 provides continuous illumination by combining 3' and 4' staggered lamps.

PERFORMANCE

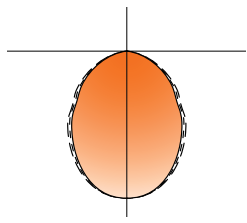
PRODUCT OVERVIEW	
Lumen Output:	1520-3600lm
Wattage:	33-55W
Lamping:	T5, T5HO, T8
	
1-Lamp T5 High Performance Lens	1-Lamp T5 Flush Satin Lens
77% Efficient	56% Efficient
999 cd @ 0°	595 cd @ 0°
Visit focalpointlights.com for complete photometric data.	

fixture:

project:

MOUNTING INFORMATION

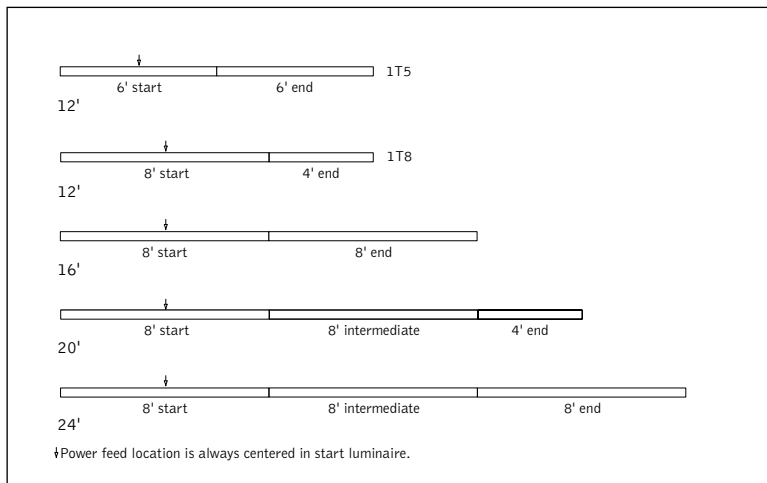

SPECIFICATIONS

Construction

One piece, .07" thick housing of 6063-T5 extruded aluminum. Cast aluminum end caps. Lengths 6' and longer configured with staggered lamps: T8: 4.47" overlap, T5/T5HO: 4.35" overlap. 2' unit weight: 18 lbs., 3' unit weight: 24 lbs., 4' unit weight: 30 lbs., 5' unit weight: 36 lbs., 6' unit weight: 43 lbs., 8' unit weight: 55 lbs.

Optic

Reflectors fabricated of 22 Ga. Steel finished in High Reflectance White powder coat. Flush satin lens: extruded acrylic lens .07" thick with opal satin finish. High performance flush lens: extruded acrylic lens .07" thick with increased light transmission. Lenses up to 8' continuous.

Electrical

Requires 2x4 single gang junction box for power feed. Luminaires are pre-wired with factory installed branch circuit wiring and over-molded quick connects. Electronic fluorescent ballasts are thermally protected and have a Class "P" rating. Optional dimming ballasts available.

Labels

UL and cUL listed.

Finish

Polyester powder coat applied over a 5-stage pre-treatment.

ORDERING

Luminaire Series		FSM4W
Seem 4	FSM4W	_____
Shielding		_____
Flush Satin Lens	FL	_____
High Performance Flush Lens	FLXP	_____
<small>(Lamp image may be visible)</small>		
Lamping		_____
One Lamp T8	1T8	_____
One Lamp T5	1T5	_____
One Lamp T5HO	1T5HO	_____
Circuit		1C
Single Circuit	1C	_____
Voltage		_____
120 Volt	120	_____
277 Volt	277	_____
347 Volt	347	_____
<small>(Consult factory for dimming options)</small>		
UNV Volt	UNV	_____
<small>(Cannot be specified with 1T5HO dimming or EM options)</small>		
Ballast		_____
Electronic Program Start <10% THD	S	_____
0-10V	D7	_____
Lutron 1% 3-wire	DH	_____
Lutron 1% H-Series	DK	_____
Mounting		WM
Wall Mount	WM	_____
Factory Options		_____
Emergency Circuit*	EC	_____
Emergency Battery Pack*	EM	_____
HLR/GLR Fuse	FU	_____
Include 3000K Lamp*	L830	_____
Include 3500K Lamp*	L835	_____
Include 4100K Lamp*	L841	_____
Finish		_____
Titanium Silver	TS	_____
Matte White Housing	WH	_____
Luminaire Length		_____
	2'	2'
	3'	3'
	4'	4'
	5'	5'
	6'	6'
	7'	7'
Specify row lengths 8' and longer in 4' increments	X'	_____
<small>(Lengths 6' and longer configured with staggered lamps)</small>		

Seem® 4

FLUORESCENT - HIGH PERFORMANCE FLUSH LENS

FSM4-FLXP-1T5-1C-120-S-G1-WH-4'

Filename: FSM4FLXP1T5.IES
Test #: 15712.0

Lumens: 2220lm
Efficiency: 77%

CANDLEPOWER DISTRIBUTION

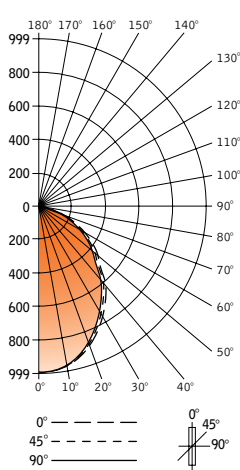

Vertical Angle	Horizontal Angle				Zonal Lumens
	0°	22.5°	45°	67.5°	
0°	999	999	999	999	999
5°	997	996	994	994	994
15°	942	941	937	93	931
25°	831	827	817	806	802
35°	692	685	670	654	648
45°	510	503	484	466	458
55°	378	373	355	338	319
65°	236	23	219	210	205
75°	118	116	111	105	103
85°	31	29	28	28	28
90°	0	0	0	0	0
95°	0	0	0	0	0
105°	0	0	0	0	0
115°	0	0	0	0	0
125°	0	0	0	0	0
135°	0	0	0	0	0
145°	0	0	0	0	0
155°	0	0	0	0	0
165°	0	0	0	0	0
175°	0	0	0	0	0
180°	0	0	0	0	0

LUMEN SUMMARY

Zone	Lumens	% Lamp	% Fixture
0-30°	738	25.5	33.3
0-40°	1159	40.0	52.2
0-60°	1853	63.9	83.5
0-90°	2220	76.6	100
Total Luminaire 0-180°	2220	76.6	100

LUMINANCE DATA (CD/M²)

Vertical Angle	0°	45°	90°
45°	6091	5781	5470
55°	5566	5227	4903
65°	4716	7376	4097
75°	3850	3622	3361
85°	3004	2713	2713

CO-EFFICIENTS OF UTILIZATION

Floor Ceiling Wall	80				70			20		30		10		00
	70	50	30	10	70	50	10	50	10	50	10	50	10	00
RCR 0	91	91	91	91	89	89	89	85	85	81	81	78	78	77
1	85	81	78	76	82	80	75	76	72	73	70	71	68	67
2	78	72	68	64	76	71	63	68	62	66	60	64	59	58
3	72	65	59	55	70	64	54	61	53	59	53	58	52	50
4	66	58	52	47	65	57	47	55	46	54	46	52	45	44
5	61	52	46	41	59	51	41	49	40	48	40	47	39	38
6	56	47	40	36	55	46	36	45	35	44	35	42	35	33
7	52	42	35	32	51	42	32	41	31	40	31	39	31	29
8	48	38	32	8	47	38	28	37	27	36	27	35	27	26
9	45	35	28	24	43	34	24	33	24	32	24	32	24	22
10	41	31	26	22	40	31	22	30	21	30	21	29	21	20

Numbers indicate percentage values of reflectivity.

Go to www.focalpointlights.com for additional photometric data.

Seem® 4

FLUORESCENT - FLUSH LENS

FSM4-FL-1T5-1C-120-S-G1-WH-4'

Filename: FSM4FL1T5.IES
Test #: 15711.0

Lumens: 1617lm
Efficiency: 56%

CANDLEPOWER DISTRIBUTION

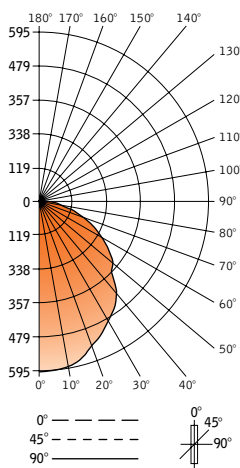

Vertical Angle	Horizontal Angle				Zonal Lumens
	0°	22.5°	45°	67.5°	
0°	595	595	595	595	595
5°	591	591	591	591	591
15°	568	568	568	568	568
25°	515	515	515	515	515
35°	455	455	455	455	455
45°	353	355	355	355	355
55°	288	288	288	290	290
65°	198	196	198	198	199
75°	108	109	109	109	109
85°	28	28	28	28	29
90°	0	0	0	0	0
95°	0	0	0	0	0
105°	0	0	0	0	0
115°	0	0	0	0	0
125°	0	0	0	0	0
135°	0	0	0	0	0
145°	0	0	0	0	0
155°	0	0	0	0	0
165°	0	0	0	0	0
175°	0	0	0	0	0
180°	0	0	0	0	0

LUMEN SUMMARY

Zone	Lumens	% Lamp	% Fixture
0-30°	456	15.7	28.2
0-40°	742	25.6	45.9
0-60°	1275	44.0	78.9
0-90°	1617	55.8	100
Total Luminaire 0-180°	1617	55.8	100

LUMINANCE DATA (CD/M²)

Vertical Angle	0°	45°	90°
45°	4216	4240	4240
55°	4241	4241	4270
65°	3957	3957	3977
75°	3524	3557	3557
85°	2713	2713	2810

CO-EFFICIENTS OF UTILIZATION

Floor Ceiling Wall	80				70			20		30		10		00
	70	50	30	10	70	50	10	50	10	50	10	50	10	00
RCR 0	66	66	66	66	65	65	65	62	62	59	59	57	57	56
1	61	59	56	54	60	57	53	55	52	53	50	51	49	48
2	56	52	48	45	54	51	44	49	43	47	42	45	41	40
3	51	46	41	38	50	45	38	43	37	42	36	40	36	35
4	47	41	36	32	46	40	32	39	32	37	31	36	31	30
5	43	36	31	27	42	35	27	34	27	33	27	32	26	25
6	40	32	27	24	39	32	24	31	23	30	23	29	23	22
7	36	29	24	21	36	29	21	28	21	27	20	26	20	19
8	34	26	21	18	33	26	18	25	18	24	18	24	18	17
9	31	23	19	16	30	23	16	22	15	22	15	21	15	14
10	29	21	17	14	28	21	14	20	14	20	14	19	14	13

Numbers indicate percentage values of reflectivity.

Go to www.focalpointlights.com for additional photometric data.

Seem® 4

FLUORESCENT - HIGH PERFORMANCE FLUSH LENS

FSM4-FLXP-1T8-1C-120-S-TF-WH-4'

Filename: FSM4FLXP1T8.IES
Test #: 15815.0

Lumens: 2114lm
Efficiency: 72%

CANDLEPOWER DISTRIBUTION

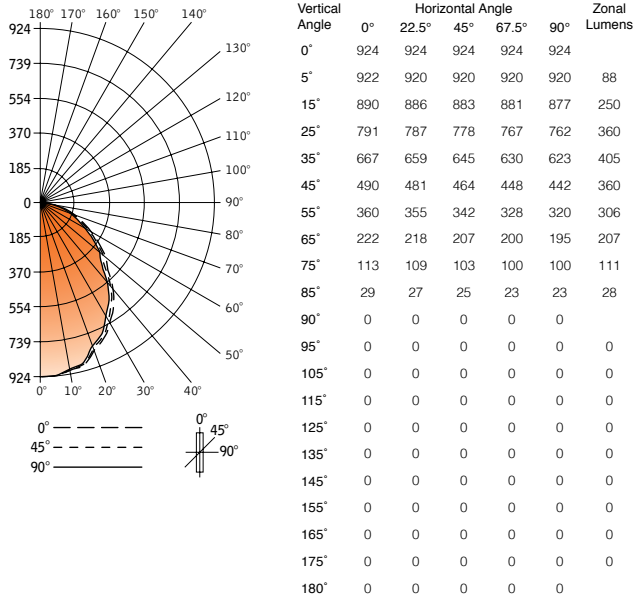

LUMEN SUMMARY

Zone	Lumens	% Lamp	% Fixture
0-30°	698	23.7	33.0
0-40°	1103	37.4	52.2
0-60°	1769	60.0	83.7
0-90°	2114	71.7	100
Total Luminaire 0-180°	2114	71.7	100

LUMINANCE DATA (CD/M²)

Vertical Angle	0°	45°	90°
45°	5921	5607	5341
55°	5363	5095	4767
65°	4489	4185	3943
75°	3731	3401	3302
85°	2843	2451	2255

CO-EFFICIENTS OF UTILIZATION

	80				70				20				50				30				10				00			
	Floor	Ceiling	Wall	RCR	Floor	Ceiling	Wall	RCR	Floor	Ceiling	Wall	RCR	Floor	Ceiling	Wall	RCR	Floor	Ceiling	Wall	RCR	Floor	Ceiling	Wall	RCR	Floor	Ceiling	Wall	RCR
0	85	85	85	85	83	83	83	83	80	80	80	80	76	76	76	76	73	73	73	73	72	72	72	72	72	72	72	72
1	79	76	74	71	77	75	70	72	68	69	66	66	64	64	62	64	62	64	62	64	62	64	62	64	62	64	62	64
2	73	68	64	60	71	66	59	64	58	62	57	60	55	54	58	55	54	58	55	54	58	55	54	58	55	54	58	55
3	67	61	56	51	66	60	51	58	50	56	49	54	48	47	52	49	48	52	49	48	52	49	48	52	49	48	52	49
4	62	54	49	44	61	53	44	52	44	50	43	49	42	41	48	45	44	48	45	44	48	45	44	48	45	44	48	45
5	57	49	43	38	56	48	38	46	38	45	37	44	37	36	43	40	37	43	40	37	43	40	37	43	40	37	43	40
6	53	44	38	34	51	43	33	42	33	41	33	40	33	32	39	36	33	39	36	33	39	36	33	39	36	33	39	36
7	49	40	34	30	48	39	29	38	29	37	29	36	29	28	35	32	29	35	32	29	35	32	29	35	32	29	35	32
8	45	36	30	26	44	35	26	34	26	33	26	33	26	25	32	29	26	32	29	26	32	29	26	32	29	26	32	29
9	42	32	27	23	41	32	23	31	22	30	22	29	22	21	28	25	22	28	25	22	28	25	22	28	25	22	28	25
10	39	29	24	20	38	29	20	28	20	27	20	27	20	19	26	23	20	26	23	20	26	23	20	26	23	20	26	23

Numbers indicate percentage values of reflectivity.

Go to www.focalpointlights.com for additional photometric data.

Seem® 4

FLUORESCENT - FLUSH LENS

FSM4-FL-1T8-1C-120-S-TF-WH-4'

Filename: FSM4FL1T8.IES
Test #: 15814.0

Lumens: 1520lm
Efficiency: 52%

CANDLEPOWER DISTRIBUTION

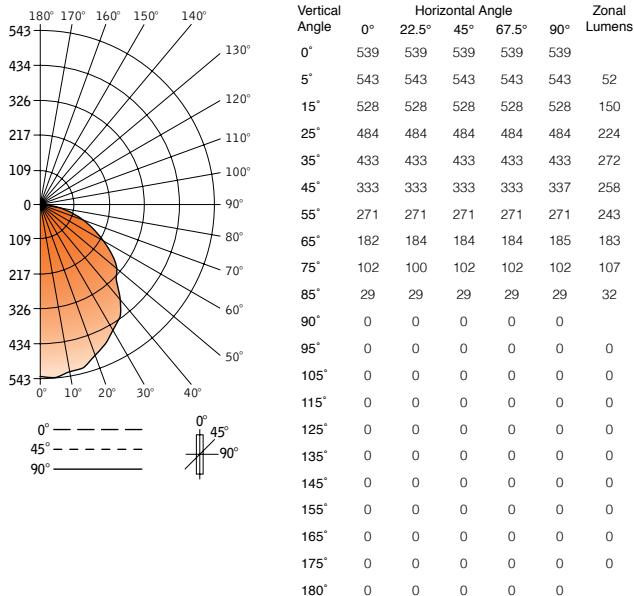

LUMEN SUMMARY

Zone	Lumens	% Lamp	% Fixture
0-30°	426	14.4	28.0
0-40°	698	23.6	45.9
0-60°	1199	40.6	78.9
0-90°	1520	51.5	100
Total Luminaire 0-180°	1520	51.5	100

LUMINANCE DATA (CD/M²)

Vertical Angle	0°	45°	90°
45°	4024	4024	4073
55°	4037	4037	4037
65°	3680	3720	3741
75°	3368	3368	3368
85°	2843	2843	2843

CO-EFFICIENTS OF UTILIZATION

	80				70				20				50				30				10				00			
	Floor	Ceiling	Wall	RCR	Floor	Ceiling	Wall	RCR	Floor	Ceiling	Wall	RCR	Floor	Ceiling	Wall	RCR	Floor	Ceiling	Wall	RCR	Floor	Ceiling	Wall	RCR	Floor	Ceiling	Wall	RCR
0	61	61	61	61	60	60	60	60	57	57	57	57	55	55	55	55	53	53	53	53	52	52	52	52	52	52	52	52
1	56	54	52	50	55	53	49	51	48	49	46	47	45	44	51	48	47	45	44	44	44	44	44	44	44	44	44	44
2	52	48	44	41	50	47	41	45	40	43	39	42	38	37	47	44	42	38	37	37	37	37	37	37	37	37	37	37
3	47	42	38	35	46	41	35	40	37	39	34	37	33	32	43	40	37	33	32	32	32	32	32	32	32	32	32	32
4	43	38	33	30	42	37	30	36	29	34	29	33	28	27	39	36	33	28	27	27	27	27	27	27	27	27	27	27
5	40	33	29	25	39	33	25	32	25	31	25	30	24	23	35	32	29	24	23	23	23	23	23	23	23	23	23	23
6	37	30	25	22	36	29	22	28	22	27	21	27	21	20	31	28	25	21	20	20	20	20	20	20	20	20	20	20
7	34	27	22	19	33	26	19	26	19	25	19	24	19	18	27	24	21	19	18	18	18	18	18	18	18	18	18	18
8	31	24	20	19	30	24	17	23	16	22	16	21	16	15	24	21	18	16	15	15	15	15	15	15	15	15	15	15
9	29	22	17	14	28	21	14	21	14	20	14	19	14	13	22	19	16	14	13	13	13	13	13	13	13	13	13	13
10	27	20	15	13	26	19	13	19	13	18	13	18	13	12	20	17	14	13	12	12	12	12	12	12	12	12	12	12

Numbers indicate percentage values of reflectivity.

Go to www.focalpointlights.com for additional photometric data.

Seem® 4

FLUORESCENT SUSPENDED, SURFACE & WALL MOUNT RUN GUIDE



EXAMPLE 16' RUN



1-T5/T5HO

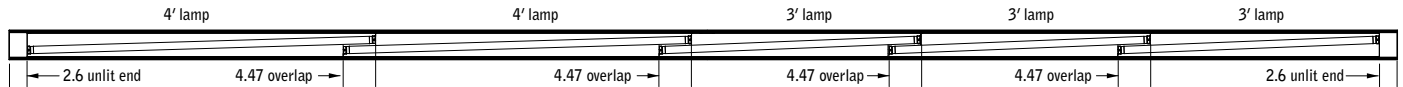

1-T8

Run length (ft)	Housing configuration	1-T5/T5HO (4.35" overlap)			1-T8 (4.47" overlap)		
		Lamp quantity		Unlit ends (in)	Lamp quantity		Unlit ends (in)
		3'	4'		3'	4'	
8	8	3		1		2.3	
12	66	2	2	0.8			
	84				3	1	0.8
16	88	2	3	1.5	3	2	3.1
20	884	5	2	1.3	6	1	1.5
24	888	1	6	1.4	2	5	1.6
28	8884	11		1.5	9	1	2.3
32	8888	7	4	1.9	5	5	2.3
36	88884	10	3	1.9	1	9	2.4
40	88888	13	2	1.9	4	8	0.9
44	888884	9	6	2.4		12	0.9
48	888888	19		2	7	8	1.6

* special lamp stagger to decrease end darkness.

Notes:

- Lamp overlap is consistent throughout run.
- Unlit ends vary to provide even light throughout run.
- Standard configurations listed, consult factory for additional options.

Notes: Lamp overlap is consistent throughout run. Unlit ends vary to provide even light throughout run. Standard configurations listed, consult factory for additional options.