

radial blade baffle

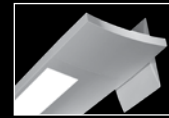

wall mount companion

## DIMENSIONAL DATA

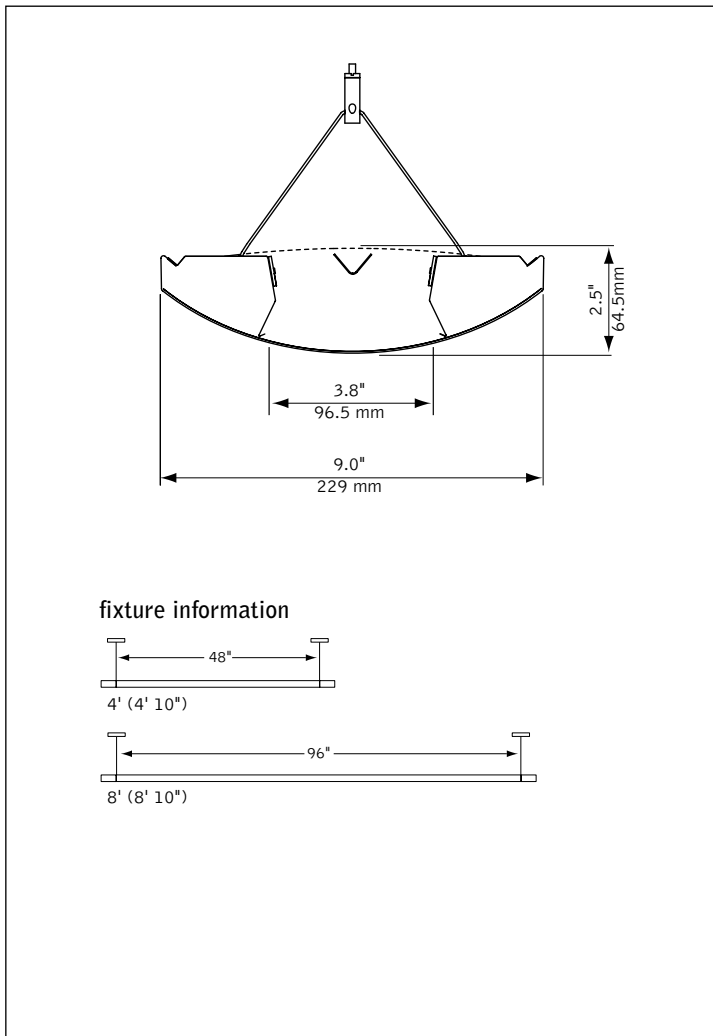

## FEATURES

Suspended linear direct/indirect LED with frosted lens or Radial Baffle options.

One-piece steel housing with 5" die-cast end caps

Verve IV is an excellent choice for commercial and educational facilities.

## PERFORMANCE

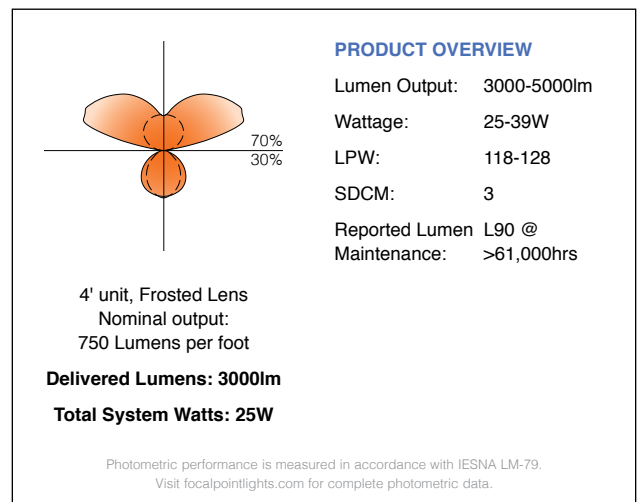

**SUSPENSION INFORMATION**

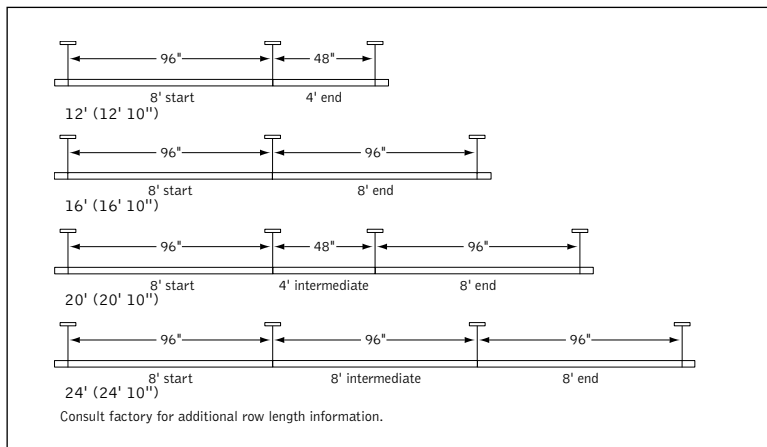

**SPECIFICATIONS**

**LED Systems**

Linear LED module incorporates premium LEDs on a robust platform to achieve excellent thermal management. Available in 3000K, 3500K, 4000K with CRI>80, 3SDCM. Contact factory for additional color temperature and CRI options. LED boards and drivers are replaceable.

**Construction**

One-piece 20 Ga. steel housing. Die-cast 5" end cap standard. For row installation, internal brackets form hairline joint. Standard lengths are available in 4' and 8'. All luminaires are provided with Y-cable suspension mounted on 48" or 96" centers. 4' unit weight: 20 lbs., 8' unit weight: 30 lbs.

**Optic**

Reflector fabricated of 22 Ga. steel finished in high reflectance matte white. 24 Ga. steel beam softening filter finished in matte white powder coat. .010" thick acrylic lens.

**Electrical**

Luminaires are pre-wired with factory installed branch circuit wiring and over-molded quick connects. Standard 120-277V constant current driver includes 0-10V analog dimming. Power factor > .9.

**Emergency**

Iota ILB-SL-CP12. Emergency output—12 watts for 90 minutes. Maximum mounting height: 12.4ft.

**Labels**

UL and cUL listed. Suitable for Dry or Damp Locations, indoor use only.

**Finish**

Polyester powder coat applied over a 5-stage pre-treatment. Canopy finished in Matte Satin White.

**Lumen Maintenance**

Calculated: L90 at 100,000 hours      Reported: L90 at >61,000 hours  
(Derived from EPA TM-21 calculator based on 10,000hrs of LED test data.)

**Warranty**

LED system rated for operation in ambient environments up to 25°C. 5-year limited warranty.

**4' PERFORMANCE CHART**

Lumens Per Foot	Delivered Lumens	System Watts	LPW
750LF	3000	25	120
875LF	3500	29	121
1000LF	4000	34	118
1125LF	4500	36	125
1250LF	5000	39	128

Based on Frosted Lens 70 indirect / 30 direct (FL70), 3500K. Shielding Multipliers: FL40 - 0.90, RB - 1.04. Color Temperature multipliers: 3000K - 1.035, 4000K - 0.975. \*Lumen output may vary +/- 5%. Actual wattage may vary +/- 5%

**ORDERING**

Fixture Series	FV4LS	FV4LS
Verve IV LED	FV4LS	
<b>Shielding</b>		
Frosted Lens - 70 Indirect / 30 Direct Distribution	FL70	
Frosted Lens - 40 Indirect / 60 Direct Distribution	FL40	
Radial Blade Baffle - White with frosted acrylic overlay	RB	
70 Indirect / 30 Direct Distribution		
<b>Lumen Output</b>		
750 Lumens per foot	750LF	
875 Lumens per foot	875LF	
1000 Lumens per foot	1000LF	
1125 Lumens per foot	1125LF	
1250 Lumens per foot	1250LF	
<b>Color Temperature</b>		
3000K	30K	
3500K	35K	
4000K	40K	
<b>Circuits</b>		
Single Circuit	1C	<b>1C</b>
<b>Voltage</b>		
120/277 UNV Volt	UNV	
347 Volt (LD1 only)	347	
<b>Driver</b>		
<small>(See Driver Reference for driver quantities)</small>		
0-10V - 1% Dimming	L11	
0-10V - 10% Dimming	LD1	
Lutron A-Series - 1% EcoSystem Digital	L3D	
<small>(1250LF requires 2 drivers to each 4' unit. Consult factory for 3-wire control)</small>		
Lutron 5-Series - 5% EcoSystem Digital	LU5	
DALI - 1% Dimming	D11	
Step Dimming (Not available with 750LF)	SD5	
<b>Mounting</b>		
24" Cable Suspension	C24	
48" Cable Suspension	C48	
96" Cable Suspension	C96	
<small>(Add "P" for Chicago plenum. Eg: CP12) (Specify one of the following in place of "C" J - for 2' canopies at non-feed locations. CS - for sloped ceilings.)</small>		
<b>Factory Options</b>		
Emergency Battery (120/277V only)	EM	
Emergency Circuit	EC	
Dust Cover (Sensor options available—consult factory)	DC	
<b>Finish</b>		
Titanium Silver	TS	
Matte Satin White	WH	
<b>Fixture Run Length</b>		
4'	4'	
8'	8'	
12' (8'+4')	12'	
16' (8'+8')	16'	
20' (8'+4'+8')	20'	
24' (8'+8'+8')	24'	

# Verve™ IV

LED - ACRYLIC DIFFUSER

## FV4LS-FL40-1250LF-35K-1C-UNV-LD1-C24-WH-4

File: LM79\_FV4LSFL401250LF

Lumens: 4515lm

System Watts: 38W

LPW: 118

### CANDLEPOWER DISTRIBUTION

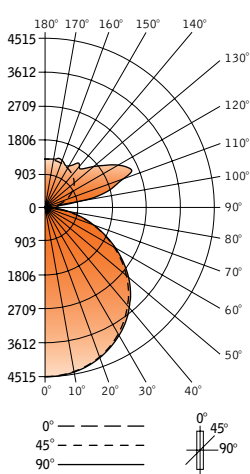

Vertical Angle	Horizontal Angle				Zonal Lumens
	0°	22.5°	45°	67.5°	
0°	1031	1031	1031	1031	1031
5°	1025	1030	1023	1025	73
15°	985	991	985	987	160
25°	907	912	908	911	224
35°	795	800	800	806	257
45°	662	667	669	676	256
55°	510	515	517	521	220
65°	352	355	356	357	160
75°	198	199	200	205	89
85°	56	59	66	71	22
90°	2	14	26	35	25
95°	36	64	52	68	54
105°	92	175	305	339	153
115°	147	180	347	493	165
125°	195	202	278	402	127
135°	232	243	296	311	104
145°	259	277	262	311	83
155°	277	283	293	283	61
165°	289	293	296	308	35
175°	295	296	295	297	7
180°	296	296	296	296	296

### LUMEN SUMMARY

Zone	Lumens	% Fixture
0-40°	1297	28.7
0-60°	2277	50.4
0-90°	2917	64.6
90-180°	1598	35.4
<b>Total Luminaire 0-180°</b>	<b>4515</b>	<b>100.0</b>

### LUMINANCE DATA (CD/M²)

Vertical Angle	Horizontal		
	0°	45°	90°
45°	5527	6155	8927
55°	4486	5121	8256
65°	3375	3948	7379
75°	2156	2608	6415
85°	734	1083	4840

### CO-EFFICIENTS OF UTILIZATION

Floor Ceiling Wall	80				70			20 50		30		10		00
	70	50	30	10	70	50	10	50	10	50	10	50	10	00
RCR 0	4994	4994	4994	4994	4692	4692	4692	4129	4129	3613	3613	3140	3140	2917
1	4546	4338	4152	3985	4262	4081	3770	3600	3362	3157	2980	2750	2620	2422
2	4131	3777	3485	3239	3866	3557	3078	3143	2768	2761	2472	2407	2189	2012
3	3763	3314	2966	2689	3519	3123	2563	2765	2318	2433	2081	2125	1853	1692
4	3441	2930	2556	2270	3216	2765	2169	2453	1970	2163	1777	1894	1589	1444
5	3158	2610	2227	1944	2953	2466	1861	2193	1697	1940	1537	1703	1381	1248
6	2910	2342	1960	1687	2722	2216	1617	1976	1480	1752	1345	1543	1212	1091
7	2692	2115	1742	1480	2520	2004	1421	1792	1304	1594	1189	1407	1075	965
8	2500	1922	1559	1310	2342	1824	1259	1635	1159	1458	1060	1292	962	860
9	2329	1757	1406	1170	2185	1669	1126	1500	1039	1342	952	1192	867	774
10	2178	1614	1276	1052	2045	1535	1013	1383	987	1240	862	1105	787	701

Numbers indicate percentage values of reflectivity.

Go to [www.focalpointlights.com](http://www.focalpointlights.com) for additional photometric data.

# Verve™ IV

LED - ACRYLIC DIFFUSER

## FV4LS-FL70-1250LF-35K-1C-UNV-LD1-C24-WH-4

File: LM79\_FV4LSFL70750LF

Lumens: 2967lm

System Watts: 25W

LPW: 120

### CANDLEPOWER DISTRIBUTION

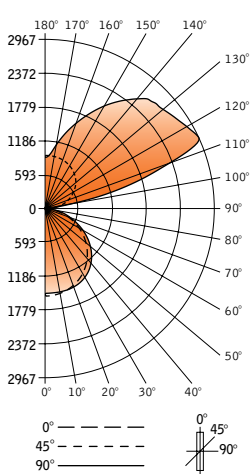

Vertical Angle	Horizontal Angle				Zonal Lumens
	0°	22.5°	45°	67.5°	
0°	332	332	332	332	332
5°	339	333	329	329	24
15°	327	323	322	326	53
25°	305	302	307	314	77
35°	272	271	279	288	90
45°	229	230	239	246	91
55°	179	181	187	193	80
65°	125	126	130	133	58
75°	71	71	73	77	33
85°	21	25	28	30	9
90°	1	7	12	14	14
95°	23	36	17	15	34
105°	71	260	347	298	174
115°	108	303	469	599	212
125°	139	300	484	576	188
135°	166	288	454	563	153
145°	185	272	400	488	107
155°	198	247	338	395	64
165°	206	220	263	297	29
175°	209	206	208	213	5
180°	203	203	203	203	203

### LUMEN SUMMARY

Zone	Lumens	% Fixture
0-30°	265	8.9
0-40°	440	14.8
0-60°	791	26.7
0-90°	1029	34.7
<b>Total Luminaire 0-180°</b>	<b>2967</b>	<b>100.0</b>

### LUMINANCE DATA (CD/M²)

Vertical Angle	Horizontal		
	0°	45°	90°
45°	3143	3011	3061
55°	3019	2801	2815
65°	2840	2480	2432
75°	2589	2006	2007
85°	2084	1427	1385

### CO-EFFICIENTS OF UTILIZATION

Floor Ceiling Wall	80				70			20 50		30		10		00
	70	50	30	10	70	50	10	50	10	50	10	50	10	00
RCR 0	3071	3071	3071	3071	2774	2774	2774	2220	2220	1713	1713	1248	1248	1029
1	2791	2661	2545	2441	2515	2406	2220	1929	1800	1491	1405	1087	1034	848
2	2535	2316	2134	1982	2280	2096	1810	1683	1479	1302	1163	949	861	700
3	2308	2029	1813	1642	2074	1838	1504	1478	1235	1145	976	836	726	586
4	2106	1790	1557	1380	1892	1623	1267	1308	1045	1015	830	743	620	498
5	1929	1588	1350	1174	1733	1442	1080	1165	895	907	713	666	536	429
6	1773	1419	1182	1011	1593	1290	932	1045	774	816	620	602	468	374
7	1635	1276	1043	880	1471	1161	812	943	677	739	544	547	413	329
8	1514	1154	928	772	1363	1052	713	856	597	673	481	501	368	293
9	1406	1049	831	683	1267	958	632	782	530	617	429	461	330	262
10	1311	959	748	608	1182	876	563	717	474	568	385	426	298	237

Numbers indicate percentage values of reflectivity.

Go to [www.focalpointlights.com](http://www.focalpointlights.com) for additional photometric data.

### CANDLEPOWER DISTRIBUTION

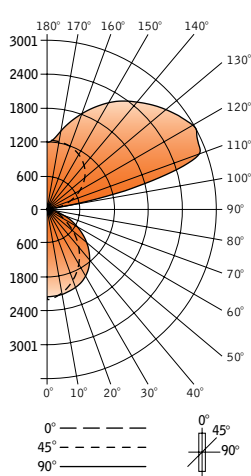

Vertical Angle	Horizontal Angle				Zonal Lumens
	0°	22.5°	45°	67.5°	
0°	362	362	362	362	362
5°	364	358	355	357	358
15°	331	327	331	340	348
25°	285	284	292	314	329
35°	230	229	246	270	291
45°	168	170	187	212	235
55°	103	107	124	147	169
65°	59	60	67	86	101
75°	32	33	34	39	39
85°	10	14	15	14	5
90°	1	6	7	6	4
95°	24	59	16	12	47
105°	77	286	461	429	403
115°	130	310	510	626	663
125°	178	333	496	613	654
135°	219	336	477	568	601
145°	247	330	443	516	540
155°	267	313	392	446	463
165°	278	291	330	363	373
175°	282	279	280	285	286
180°	276	276	276	276	276

### LUMEN SUMMARY

Zone	Lumens	% Fixture
0-30°	266	8.9
0-40°	423	14.1
0-60°	686	22.8
0-90°	812	27.0
<b>Total Luminaire</b>	<b>0-180°</b>	<b>3001</b>

### LUMINANCE DATA (cd/M²)

Vertical Angle	Horizontal		
	0°	45°	90°
45°	2308	2362	2883
55°	1731	1855	2428
65°	1349	1277	1824
75°	1169	945	989
85°	1007	769	603

### CO-EFFICIENTS OF UTILIZATION

Floor Ceiling Wall	80				70			20 50		30		10		00
	70	50	30	10	70	50	10	50	10	50	10	50	10	
RCR 0	3051	3051	3051	3051	2726	2726	2726	2118	2118	1562	1562	1052	1052	812
1	2785	2662	2551	2452	2484	2383	2208	1860	1743	1379	1307	936	896	694
2	2540	2330	2157	2011	2263	2089	1820	1636	1451	1218	1100	831	764	592
3	2320	2052	1844	1679	2065	1842	1525	1447	1225	1081	936	742	657	509
4	2122	1816	1592	1421	1889	1633	1294	1287	1046	965	805	666	570	442
5	1946	1616	1385	1215	1733	1455	1109	1150	901	867	698	602	499	387
6	1791	1447	1216	1051	1596	1305	961	1035	784	783	611	547	441	343
7	1654	1303	1076	917	1475	1177	841	937	689	711	540	500	393	306
8	1532	1180	959	807	1367	1067	741	852	609	649	480	459	352	275
9	1424	1074	860	715	1272	972	658	779	543	596	430	424	318	249
10	1327	982	775	637	1187	890	587	715	487	549	387	393	289	227

Numbers indicate percentage values of reflectivity.

Go to [www.focalpointlights.com](http://www.focalpointlights.com) for additional photometric data.