

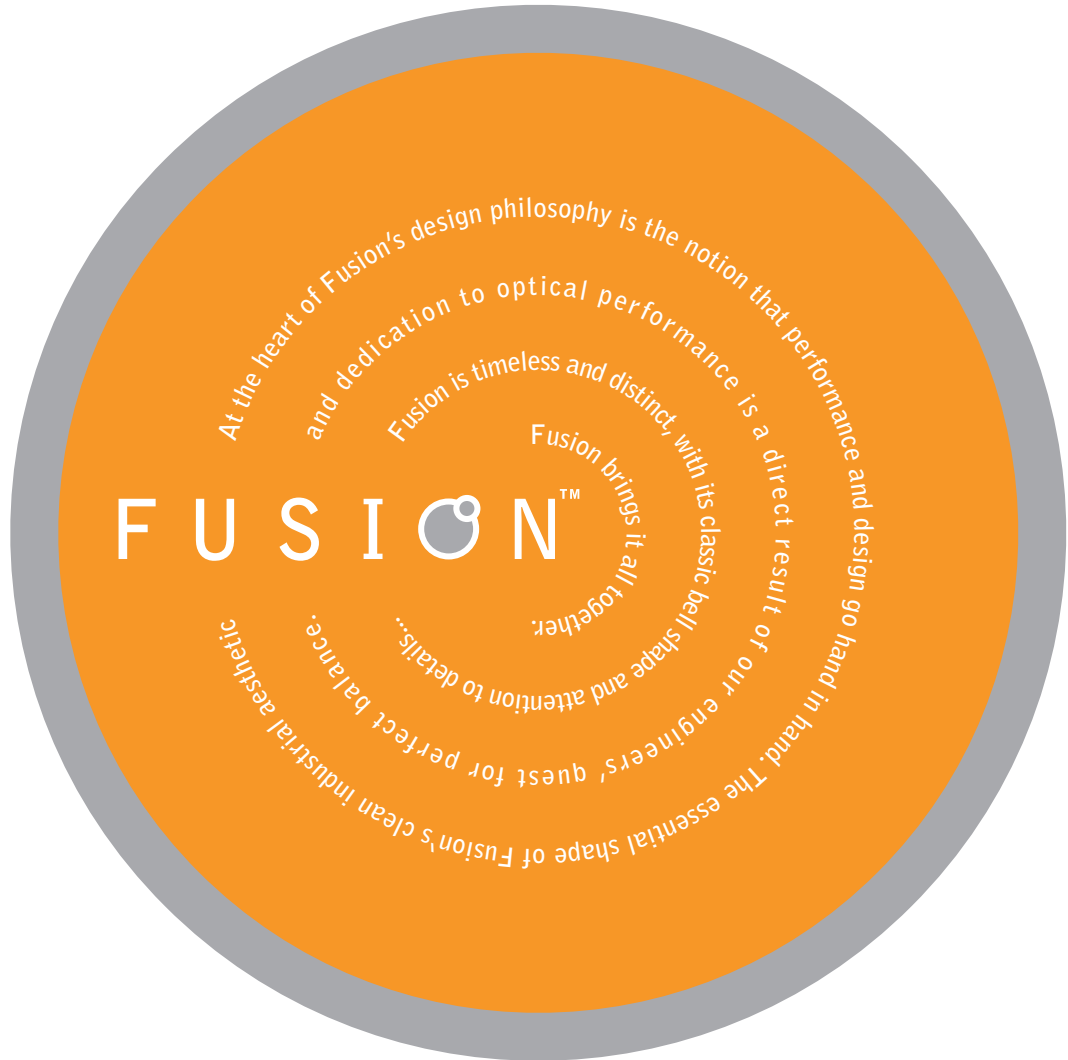

FUSION™





# FUSION™

At the heart of Fusion's design philosophy is the notion that performance and design go hand in hand. The essential shape of Fusion's clean industrial aesthetic and dedication to optical performance is a direct result of our engineers' quest for perfect balance...

Fusion brings it all together with its classic bell shape and attention to details...





*fluorescent with solid reflector*



frosted blue  
uplight ring



frosted green  
uplight ring

*fluorescent with frosted white uplight ring*



*metal halide*



fluorescent with solid reflector

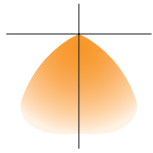
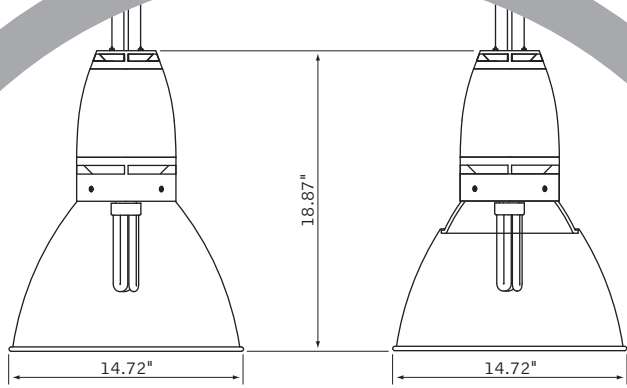

1-lamp 42W triple tube  
67% efficiency  
885 cd @ 20°  
100% direct



1, 2, 3 & 4 Lamp  
32W & 42W Triple Tube

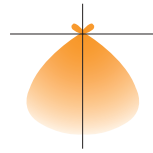

1-lamp 42W triple tube  
72% efficiency  
751 cd @ 10°  
14% indirect / 86% direct

options



frosted white  
diffusion disk



frosted green  
diffusion disk

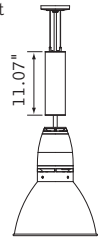

battery pack

fluorescent with frosted upright ring

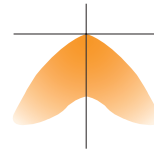
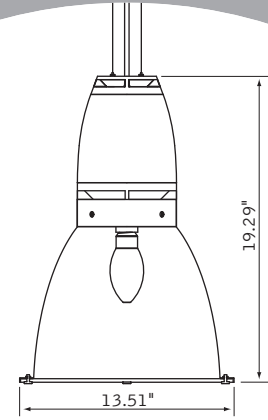

1-lamp 100W metal halide  
59% efficiency  
2298 cd @ 40°  
100% direct



1 Lamp 50W, 70W & 100W  
ED17 Metal Halide

options

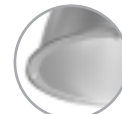

clear lens



frosted lens

metal halide

T H E  
A R T O F  
L I G H T®

All rights reserved. "Fusion", "Focal Point", "The Art of Light" and Light-Ray Graphic are registered trademarks of Focal Point LLC. 10/06 #MKT1071. Made in China.

Visit [focalpointlights.com](http://focalpointlights.com) for specifications and other details on our entire Focal Point® catalog.

© 2006 Focal Point LLC, 4201 S. Pulaski Road, Chicago, Illinois 60632 [www.focalpointlights.com](http://www.focalpointlights.com), T 773.247.9494, F 773.247.8484, [info@focalpointlights.com](mailto:info@focalpointlights.com).

Visit [focalpointlights.com](http://focalpointlights.com) for specifications and other details on our entire Focal Point® catalog.