

Mora®

INTEGRATED ACOUSTIC CEILING AND LIGHTING SYSTEM



MORA BUILD



Mora Build literally offers the building blocks to your next acoustic ceiling. The two standard designs of Arch and Wave are available in nominal square modules from 4 to 8 feet, lit or unlit. Several modules can be combined over large surface areas, resulting in rhythmic and playful ceilings.

[Go to Mora Build Arch](#)

[Go to Mora Build Wave](#)

MORA CREATE



Mora Create gives you the freedom to design custom-sized arrays to fit the exact dimensions of your room using three designs: Alpine, Radiate, or Ripple. Each offers a singular visual aesthetic and allows for placement of the continuous luminaires to fulfill the lighting requirements of the space.

[Go to Mora Create](#)

MORA INSPIRE



Let your imagination run wild with the support of our design and engineering team. We will turn your inspiration into a showpiece ceiling.

Contact us at
acoustic.solutions@focalpointlights.com
to discuss your project.

Mora® Build Arch

INTEGRATED ACOUSTIC CEILING AND LIGHTING SYSTEM



SYSTEM FEATURES

- Mora combines TruBlade® slim, 9mm thick, sound absorbing acoustic baffles with optional Seem® 1 Acoustic luminaires.
- Nominal square modules from 4 to 8 feet.
- TruBlade's top aluminum extrusion optimizes stability and straightness.
- Blade spacing of 4" , 6" or 12" on center.
- Combine A & B style modules to create patterns.
- Seem 1 Acoustic luminaires feature AirCore® patent pending, eco-friendly technology that maximizes sound absorption and reduces ecological impact.
- Frosted acrylic lens provides uninterrupted illumination, without pixels or shadows.
- Choice of lumen output levels to meet a wide variety of application needs.
- Wide range of PET color options including The Naturals, a series of finishes that exude biophilic beauty, provides design flexibility and personalization for any project.

MODULE DETAILS

Module Sizes (4" on center blade spacing shown)

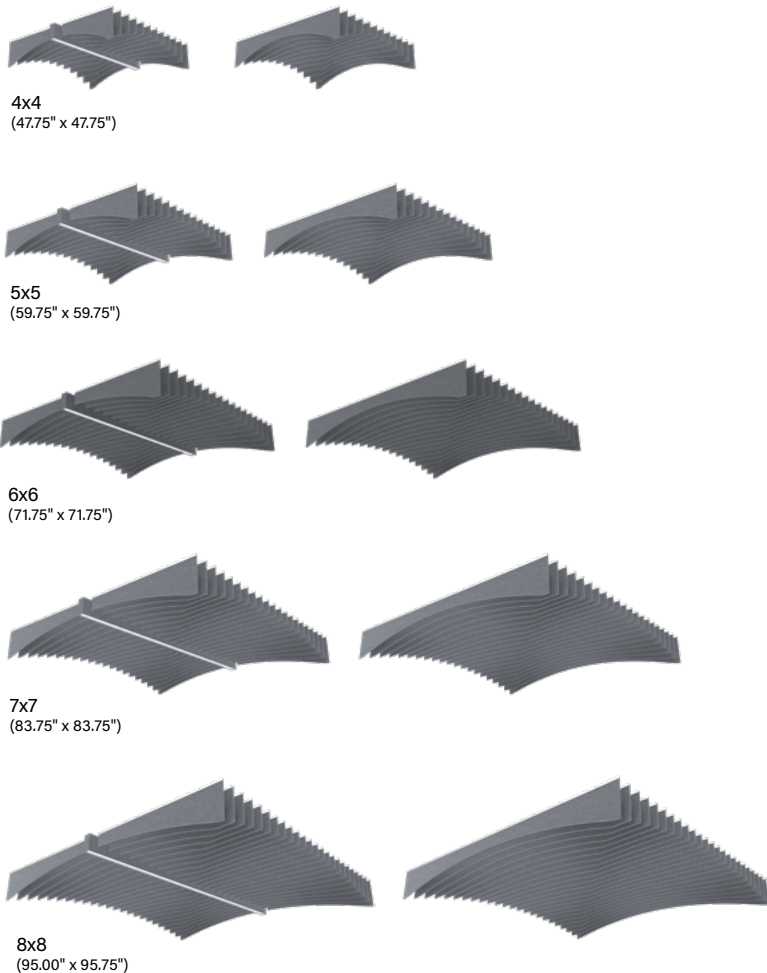

Blade Spacing (6x6 modules shown)

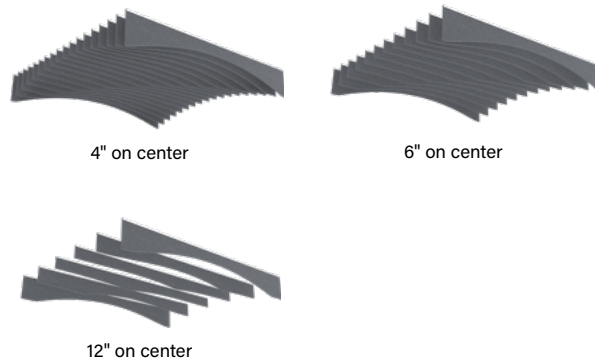

On-center Luminaire Spacing & Module Compatibility

Use the table below to determine suitable module sizes based on the desired on-center spacing of the luminaires.

LIT AND UNLIT MODULE CONFIGURATIONS	MODULE SIZE				
	4x4	5x5	6x6	7x7	8x8
	On-center luminaire spacing				
	4ft	5ft	6ft	7ft	8ft
	8ft	10ft	12ft	14ft	16ft
	12ft	15ft	18ft		
	16ft				

STYLES

Arch A (AHA)

Arch B (AHB)

The sequence of the baffles is reversed for A and B styles, yielding a totally different visual effect. Use each individually or mix and match A and B style modules to create unique ceilings.

PATTERN INSPIRATIONS

Arch 'Zig-Zag' Pattern

4x4 modules, 6" blade spacing, A & B styles

Arch 'A' Pattern

8x8 modules, 4" blade spacing, all A style

Arch 'B' Pattern

Arch 'Chevron' Pattern

Arch 'Argyle' Pattern

SYSTEM MOUNTING

DTSK

DTSM

CSK

CSM

24CS

See page 8 for strut recommendations.

LIT SYSTEM ORDERING

System Series	AMR	
Mora Build	AMR	
Style		
Arch A	AHA	
Arch B	AHB	
Acoustic Panel Color		
See page 10 for color offering		
Size (nominal)		
4' x 4'	44	
5' x 5'	55	
6' x 6'	66	
7' x 7'	77	
8' x 8'	88	
Blade Spacing		
4" on center	40C	
6" on center	60C	
12" on center	120C	
(6 x 6, 7 x 7 and 8 x 8 sizes only)		
System Mounting		
Direct to Strut Luminaires and StrutKlip Baffles	DTSK	
Direct to Strut Luminaires and Direct to Strut Magnet baffles	DTSM	
Cable Suspension Luminaires and StrutKlip baffles	CSK	
Cable Suspension Luminaires and Direct to Strut Magnet baffles	CSM	
Cable Suspension Luminaires and Baffles (24" length)	24CS	
Luminaire Series		ASM1S
Seem 1 Acoustic	ASM1S	
Shielding		
Batwing Lens	BW	
Regress Lens	RL	
Height		6
6" Nominal	6	
Lumen Output		
100 Lumens per foot (Consult factory for Lutron, DALI)	100LF	
200 Lumens per foot	200LF	
300 Lumens per foot	300LF	
400 Lumens per foot	400LF	
500 Lumens per foot	500LF	
Color Temperature		
3000K, 80CRI or 90 CRI	30K or 930K	
3500K, 80CRI or 90 CRI	35K or 935K	
4000K, 80CRI or 90 CRI	40K or 940K	
Circuits & Zones		1C
1 Circuit	1C	
Voltage		UNV
120/277 UNV Volt	UNV	
Control System & Dimming Level		
0-10V - 10% Dimming	LD1	
0-10V - 1% Dimming	L11	
Lutron Hi-Lume EcoSystem (LDE1) - 1% Dimming	LH1	
DALI 1% Dimming	D11	
Factory Options		
Black Cord	BKCD	
Emergency Circuit	_EC	
Emergency Battery Pack	_EM	

UNLIT SYSTEM ORDERING

System Series	AUMR	
Mora Build unlit	AUMR	
Style		
Arch A	AHA	
Arch B	AHB	
Acoustic Panel Color		
See page 10 for color offering		
Size (nominal)		
4' x 4'	44	
5' x 5'	55	
6' x 6'	66	
7' x 7'	77	
8' x 8'	88	
Blade Spacing		
4" on center	40C	
6" on center	60C	
12" on center	120C	
(6 x 6, 7 x 7 and 8 x 8 sizes only)		
System Mounting		
Direct to Strut: StrutKlip	DTSK	
Direct to Strut: Magnet	DTSM	
Cable Suspension (24" length)	24CS	

Mora® Build Wave

INTEGRATED ACOUSTIC CEILING AND LIGHTING SYSTEM



SYSTEM FEATURES

- Mora combines TruBlade® slim, 9mm thick, sound absorbing acoustic baffles with optional Seem® 1 Acoustic luminaires.
- Nominal square modules from 4 to 8 feet.
- TruBlade's top aluminum extrusion optimizes stability and straightness.
- Blade spacing of 4" , 6" or 12" on center.
- Combine A & B style modules to create patterns.
- Seem 1 Acoustic luminaires feature AirCore® patent pending, eco-friendly technology that maximizes sound absorption and reduces ecological impact.
- Frosted acrylic lens provides uninterrupted illumination, without pixels or shadows.
- Choice of lumen output levels to meet a wide variety of application needs.
- Wide range of PET color options including The Naturals, a series of finishes that exude biophilic beauty, provides design flexibility and personalization for any project.

MODULE DETAILS

Module Sizes (4" on center blade spacing shown)

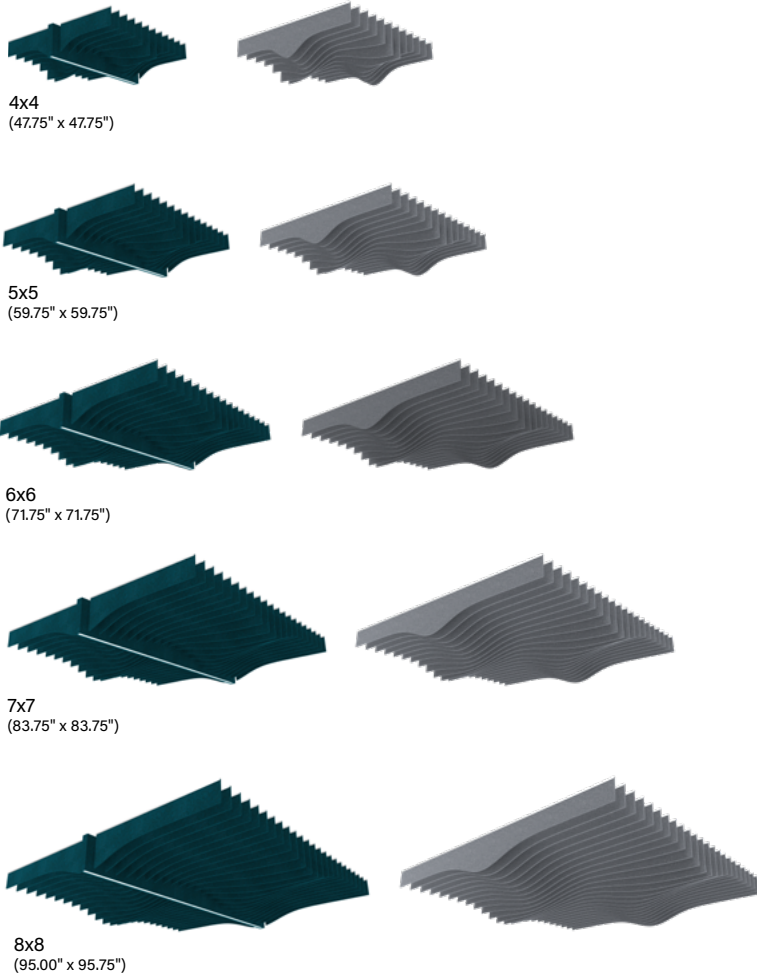

Blade Spacing (6x6 modules shown)

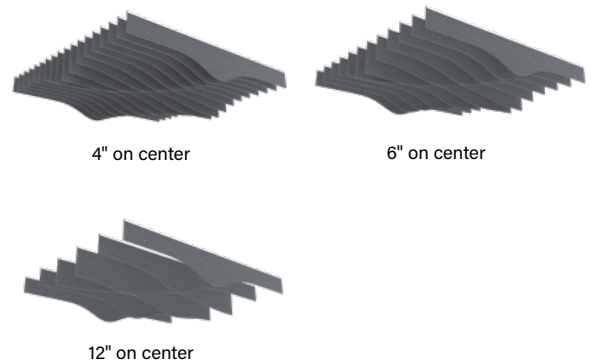

On-center Luminaire Spacing & Module Compatibility

Use the table below to determine suitable module sizes based on the desired on-center spacing of the luminaires.

LIT AND UNLIT MODULE CONFIGURATIONS	MODULE SIZE				
	4x4	5x5	6x6	7x7	8x8
	On-center luminaire spacing				
	4ft	5ft	6ft	7ft	8ft
	8ft	10ft	12ft	14ft	16ft
	12ft	15ft	18ft		
	16ft				

STYLES

Wave A (WVA)

Wave B (WVB)

The sequence of the baffles is reversed for A and B styles, yielding a totally different visual effect. Use each individually or mix and match A and B style modules to create unique ceilings.

PATTERN INSPIRATIONS

Wave 'Circle' Pattern

5x5 modules, 4" blade spacing, A & B styles, with 2" module spacing

Wave 'B' Pattern

6x6 modules, 6" blade spacing, All B style

Wave 'A' Pattern

Wave 'Organic' Pattern

Wave 'S' Pattern

SYSTEM MOUNTING

DTSK

DTSM

CSK

CSM

24CS

See page 8 for strut recommendations.

LIT SYSTEM ORDERING

System Series	AMR	
Mora Build	AMR	
Style		
Wave A	WVA	
Wave B	WVB	
Acoustic Panel Color		
See page 10 for color offering		
Size (nominal)		
4' x 4'	44	
5' x 5'	55	
6' x 6'	66	
7' x 7'	77	
8' x 8'	88	
Blade Spacing		
4" on center	40C	
6" on center	60C	
12" on center	120C	
<small>(6 x 6, 7 x 7 and 8 x 8 sizes only)</small>		
System Mounting		
Direct to Strut Luminaires and StrutKlip Baffles	DTSK	
Direct to Strut Luminaires and Direct to Strut Magnet baffles	DTSM	
Cable Suspension Luminaires and StrutKlip baffles	CSK	
Cable Suspension Luminaires and Direct to Strut Magnet baffles	CSM	
Cable Suspension Luminaires and Baffles (24" length)	24CS	
Luminaire Series		ASM1S
Seem 1 Acoustic	ASM1S	
Shielding		
Batwing Lens	BW	
Regress Lens	RL	
Height		12
12" Nominal	12	
Lumen Output		
100 Lumens per foot <small>(Consult factory for Lutron, DALI)</small>	100LF	
200 Lumens per foot	200LF	
300 Lumens per foot	300LF	
400 Lumens per foot	400LF	
500 Lumens per foot	500LF	
Color Temperature		
3000K, 80CRI or 90 CRI	30K or 930K	
3500K, 80CRI or 90 CRI	35K or 935K	
4000K, 80CRI or 90 CRI	40K or 940K	
Circuits & Zones		1C
1 Circuit	1C	
Voltage		UNV
120/277 UNV Volt	UNV	
Control System & Dimming Level		
0-10V - 10% Dimming	LD1	
0-10V - 1% Dimming	L11	
Lutron Hi-Lume EcoSystem (LDE1) - 1% Dimming	LH1	
DALI 1% Dimming	D11	
Factory Options		
Black Cord	BKCD	
Emergency Circuit	_EC	
Emergency Battery Pack	_EM	

UNLIT SYSTEM ORDERING

System Series	AUMR	
Mora Build unlit	AUMR	
Style		
Wave A	WVA	
Wave B	WVB	
Acoustic Panel Color		
See page 10 for color offering		
Size (nominal)		
4' x 4'	44	
5' x 5'	55	
6' x 6'	66	
7' x 7'	77	
8' x 8'	88	
Blade Spacing		
4" on center	40C	
6" on center	60C	
12" on center	120C	
<small>(6 x 6, 7 x 7 and 8 x 8 sizes only)</small>		
System Mounting		
Direct to Strut: StrutKlip	DTSK	
Direct to Strut: Magnet	DTSM	
Cable Suspension (24" length)	24CS	

Mora® Create

INTEGRATED ACOUSTIC CEILING AND LIGHTING SYSTEM



SYSTEM FEATURES

Mora combines TruBlade® slim, 9mm thick, sound absorbing acoustic baffles with optional continuous Seem® 1 Acoustic luminaires.

Available in three designs: Alpine, Radiate, and Ripple.

Custom sized arrays to fit the exact room dimensions.

TruBlade's top aluminum extrusion optimizes stability and straightness.

Blade spacing available in 4" , 6" or 12" on center.

Luminaire spacing in 1ft increments.

Seem 1 Acoustic luminaires feature AirCore® patent pending, eco-friendly technology that maximizes sound absorption and reduces ecological impact.

Frosted acrylic lens provides uninterrupted illumination, without pixels or shadows.

Choice of lumen output levels to meet a wide variety of application needs.

Wide range of PET color options including The Naturals, a series of finishes that exude biophilic beauty, provides design flexibility and personalization for any project.

ALPINE



Alpine elevates ceilings with its rugged, angular pattern. Defined geometric figures emerge from the surface and shift at various viewing angles.

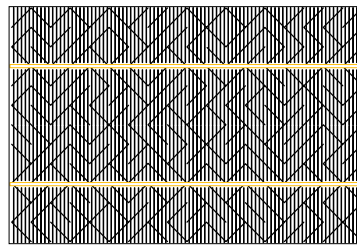

RADIATE



Radiate fills the ceiling with soft undulations that extend from a central point. The symmetrical, rhythmic pattern conveys a strong sense of direction and perspective as the motif spreads away from its origin.

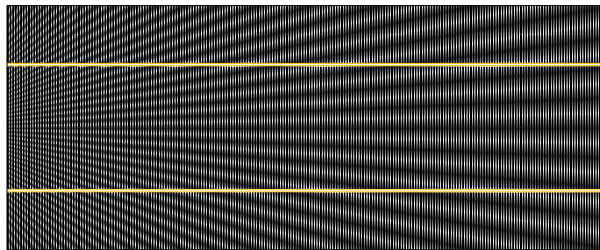

RIPPLE



Ripple's gently flowing pattern conveys an organic feel with random waves that surge and swell across the ceiling.

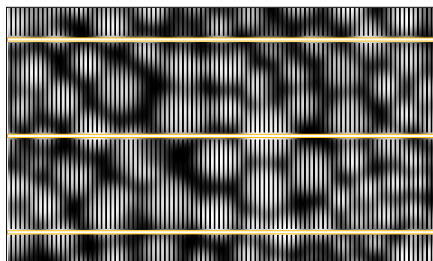

Complete form below and email to acoustic.solutions@focalpointlights.com to initiate your Mora Create project. *indicates required fields.

***What are the dimensions of your array?**

Array Length (ft) _____ Array Width (ft) _____

Blade Spacing

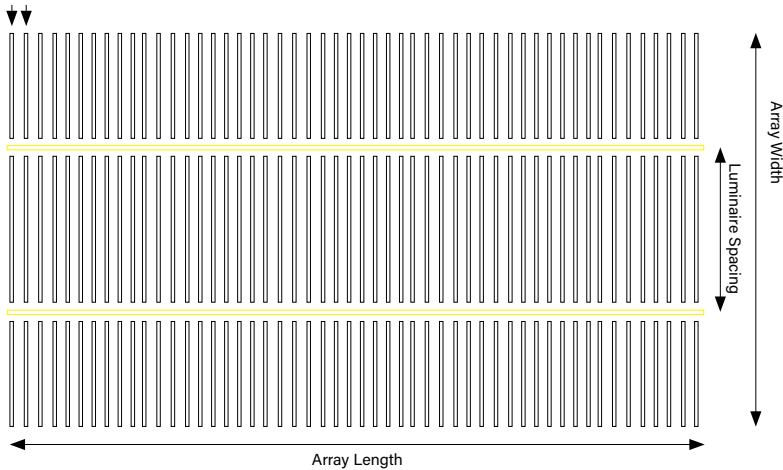

***Which design are you selecting for your array?**

- Alpine Radiate Ripple

What is your desired blade spacing (tighter spacing is recommended)?

- 4" on center 6" on center 12" on center

***Will your array include luminaires?**

- Yes No

if yes,
What is your desired luminaire on-center spacing? (ft) _____

Complete Luminaire Ordering section on page 3
(not required for project initiation, but necessary for final quotation)

What color of PET is your array (see color offering on page 10)? _____

What is your desired system mounting (see page 8 for details)?

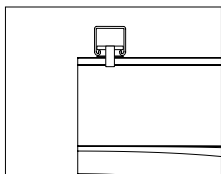

StrutKlip

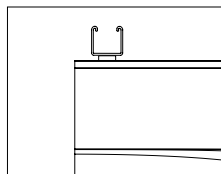

Magnet

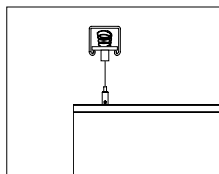

Cable Suspension

***What is the name and location of your project?**

Project name: _____

City: _____ State: _____

SYSTEM ORDERING

System Series

- Lit Mora Create AMRC _____
Unlit Mora Create AUMRC _____

Design

- Alpine ALP _____
Radiate RDT _____
Ripple RPL _____

Acoustic Panel Color

See page 10 for color offering _____

Array Length

Specify in feet ______FTX _____

Array Width

Specify in feet ______FTY _____

Blade Spacing

(4" on center spacing recommended)

- 4" on center 40C _____
6" on center 60C _____
12" on center 120C _____

Luminaire Orientation

(Leave blank for unlit systems. Contact factory for alternate orientations.)

Perpendicular to Blades PPD _____

Luminaire Spacing

(Leave blank for unlit systems)

Specify on-center luminaire spacing in 1ft increments ______FTOC _____

Blade Mounting

- Direct to Strut: StrutKlip DTSK _____
Direct to Strut: Magnet DTSM _____
Cable Suspension (24" length) 24CS _____

LUMINAIRE ORDERING

Luminaire Series

Seem 1 Acoustic ASM1S _____

Shielding

- Batwing Lens BW _____
Regress Lens RL _____

Height

12" nominal 12 _____

Lumen Output

- 100 Lumens per foot 100LF _____
(Consult factory for Lutron, DALI)
200 Lumens per foot 200LF _____
300 Lumens per foot 300LF _____
400 Lumens per foot 400LF _____
500 Lumens per foot 500LF _____

Circuits & Zones

1 Circuit, non-emergency 1C _____
Consult Ordering Guide on page 11 for multiple circuiting and zoning options
_____C_Z_DL _____

Voltage

120/277 UNV Volt UNV _____

Control System & Dimming Level

- 0-10V - 10% Dimming LD1 _____
0-10V - 1% Dimming L11 _____
Lutron Hi-Lume EcoSystem (LDE1) - 1% Dimming LH1 _____
DALI 1% Dimming D11 _____

Luminaire Mounting

(Mounting hang kits ship with order.)

- Direct/Flush to Strut DTS _____
Cable Suspension (24" length) J24 _____

Factory Options

(See Ordering Guide on page 5 for ordering details for DC, EC, EM & ECD.)

- Mora Create system component AMR _____ **AMR** _____
Black Cord BKCD _____
Daylight Circuit _DC _____
Emergency Circuit _EC _____
Emergency Battery Pack† _EM _____
Emergency Control Device† _ECD _____
†(4" minimum length.)

Acoustic Panel Color

See page 10 for color offering _____

Luminaire Length

(Luminaires are 3/4" longer than specified and cannot be cut to length in the field. Individual lengths cannot be joined in the field.)

Specify length in 1" increments from 3' to 208' _____ft_in _____

SUBMIT FORM VIA EMAIL

COMPONENT DIMENSIONAL DETAILS

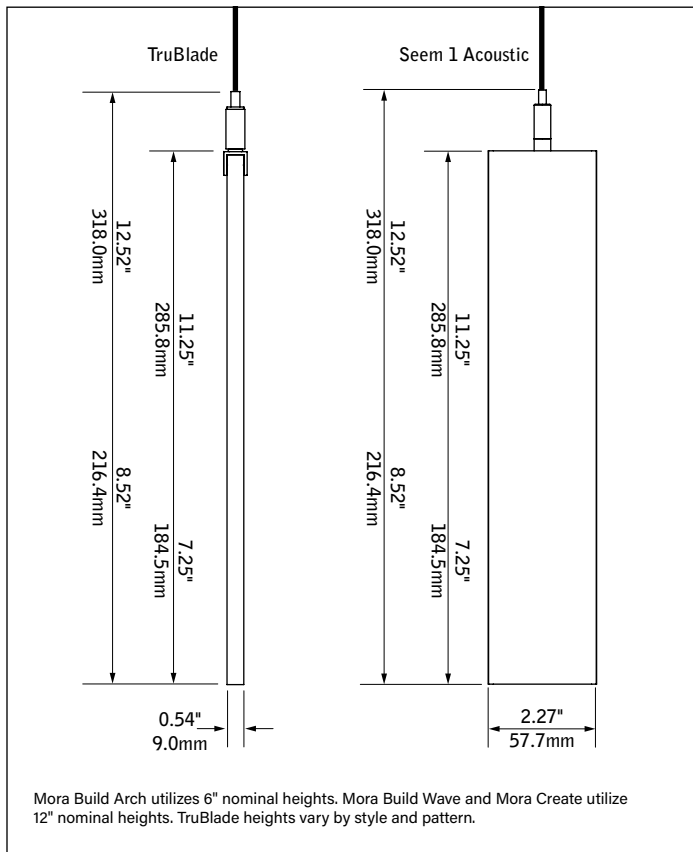

ACOUSTIC PERFORMANCE

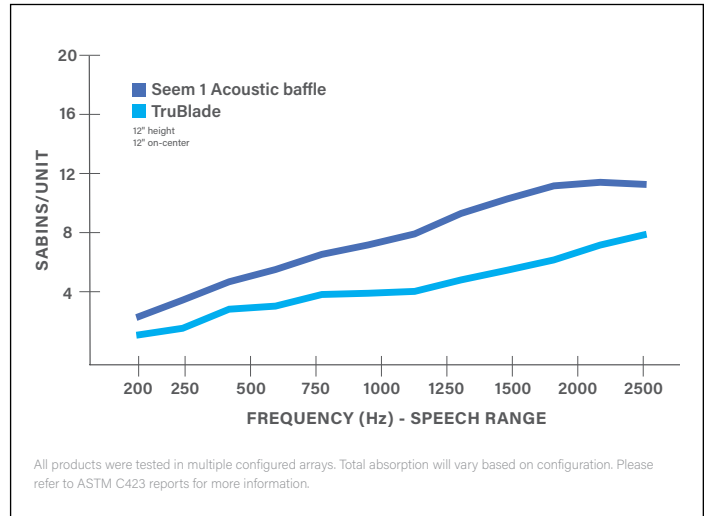

LUMINAIRE DISTRIBUTIONS & PERFORMANCE

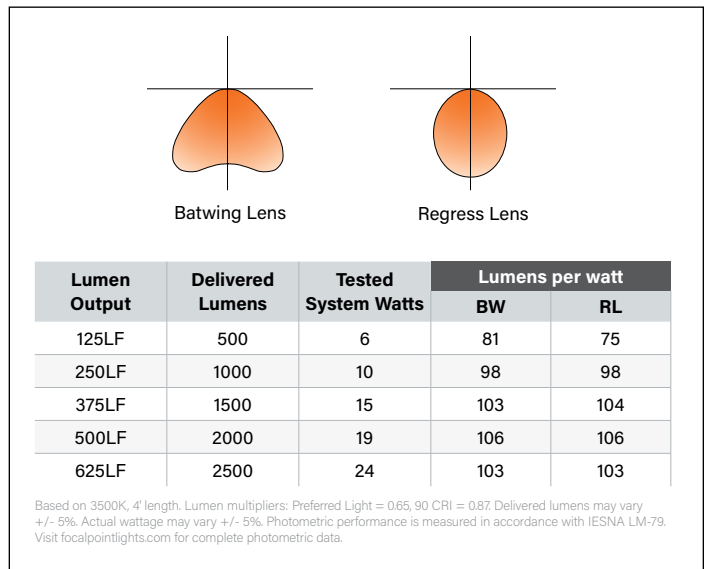

INSTALLATION METHODS

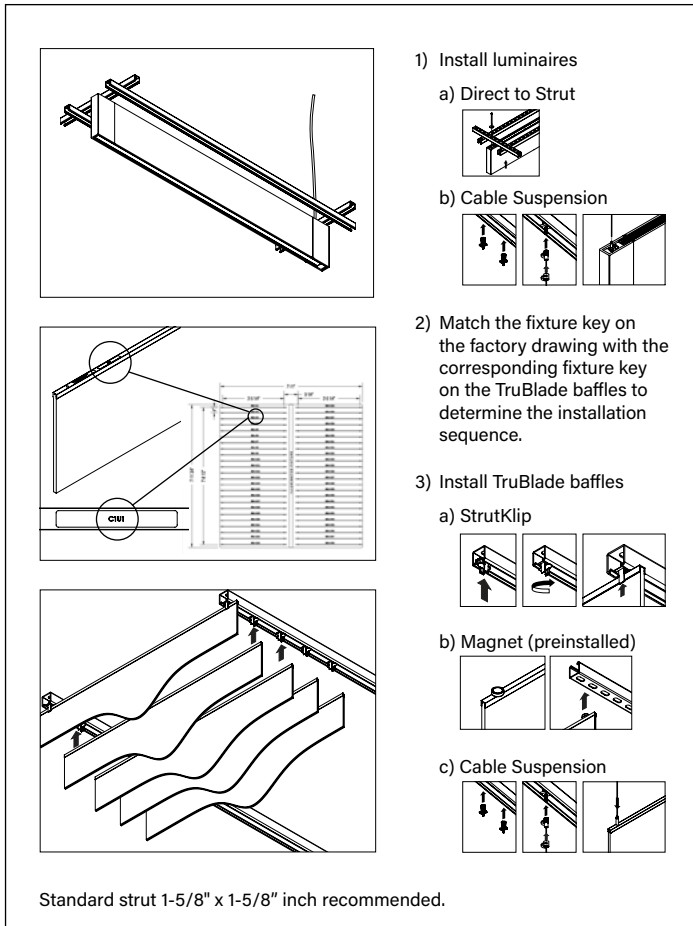

SPECIFICATIONS

Acoustic Material

Content	Housing material is 100% polyester containing up to 50% of recycled plastic bottles (PET felt) and is moisture resistant. See page 10 for color offering. Acoustic material colors are subject to change without notice. For the most current color options, please visit focalpointlights.com/acousticsolutions . Lead times may vary depending on color.
Cleaning and Care	Polyethylene Terephthalate (PET) felt can be vacuumed to remove dust. For spills and stains, blot away any excessive moisture from spills off the material as quickly as possible. Wipe the area with a damp cloth and blot dry. If the staining persists, apply a small quantity of carpet cleaner mixed with water on a dampened cloth. Blot well after each application. Make sure to test this procedure in a discreet area before you use it in a visible area.
PET Thickness	9mm
Surface Burning Characteristics	ASTM E84 Class A / CAN ULC S102 Flame Spread: 0 Smoke Development Index: 300

Acoustic Performance

Acoustic testing is performed on all Focal Point acoustic products and varies based on installation and configuration. ASTM C423 test reports can be downloaded from focalpointlights.com. Contact acoustic.solutions@focalpointlights.com for technical questions.

Sabins	Sabins is a unit of sound absorption. It measures how well one square foot of material absorbs sound. Focal Point has averaged the Sabins per unit at four specific frequency bands representing the human speech range (250, 500, 1000, 2000 Hz) to determine the Sabins per product. 8' length, 12" height: TruBlade 12" OC = 5.08 Sabins Seem 1 Acoustic 12" OC = 5.08 Sabins
---------------	---

Construction

Possible variance in blade vertical alignment due to material tolerance (+/-1°).

LED System

Proprietary linear LED module incorporates premium LEDs on a robust platform to achieve excellent thermal management. LEDs are placed to promote a uniform appearance. Available in 3000K, 3500K or 4000K with both 80 and 90 CRI options. LED drivers are replaceable from above. Color accuracy <3 SDCM.

Weight

TruBlade: will not exceed 3.75lbs per unit.

Seem 1 Acoustic: will not exceed 21.5lbs per 8ft.

Optic

Reflectors fabricated of 22 Ga. steel finished in High Reflectance White powder coat. Extruded acrylic lens .07" thick with frosted finish.

Electrical

Luminaires are pre-wired with factory installed branch circuit wiring and over-molded quick connects. Standard 120-277V constant current driver includes 0-10V analog dimming. Power factor > .9. Power cord white as standard.

Canopy (optional)

Polyester powder coat applied over a multi-stage pre-treatment. Canopy white as standard.

Emergency Battery

Emergency output - 10 watts for 90 minutes. Maximum mounting height: 16.83ft.

Labels

ETL listed in accordance with UL standards. Suitable for Dry Locations, indoor use only.

Lumen Maintenance

Reported: L70 at >61,000 hours

Calculated: L70 at 470,000 hours

L90 at >61,000 hours

L90 at 115,000 hours

Derived from EPA TM-21 calculator. Based on typical conditions, consult factory for additional data.

Reliability

At Focal Point, our products are designed to stand the test of time. Each luminaire is engineered using superior components, manufactured with the utmost care and rigorously tested. Contact us for reliability data.

Warranty

LED system rated for operation in ambient environments up to 25°C. Illuminated systems 5-year limited warranty. Unlit systems 1-year limited warranty.

MOUNTING DETAILS LUMINAIRES

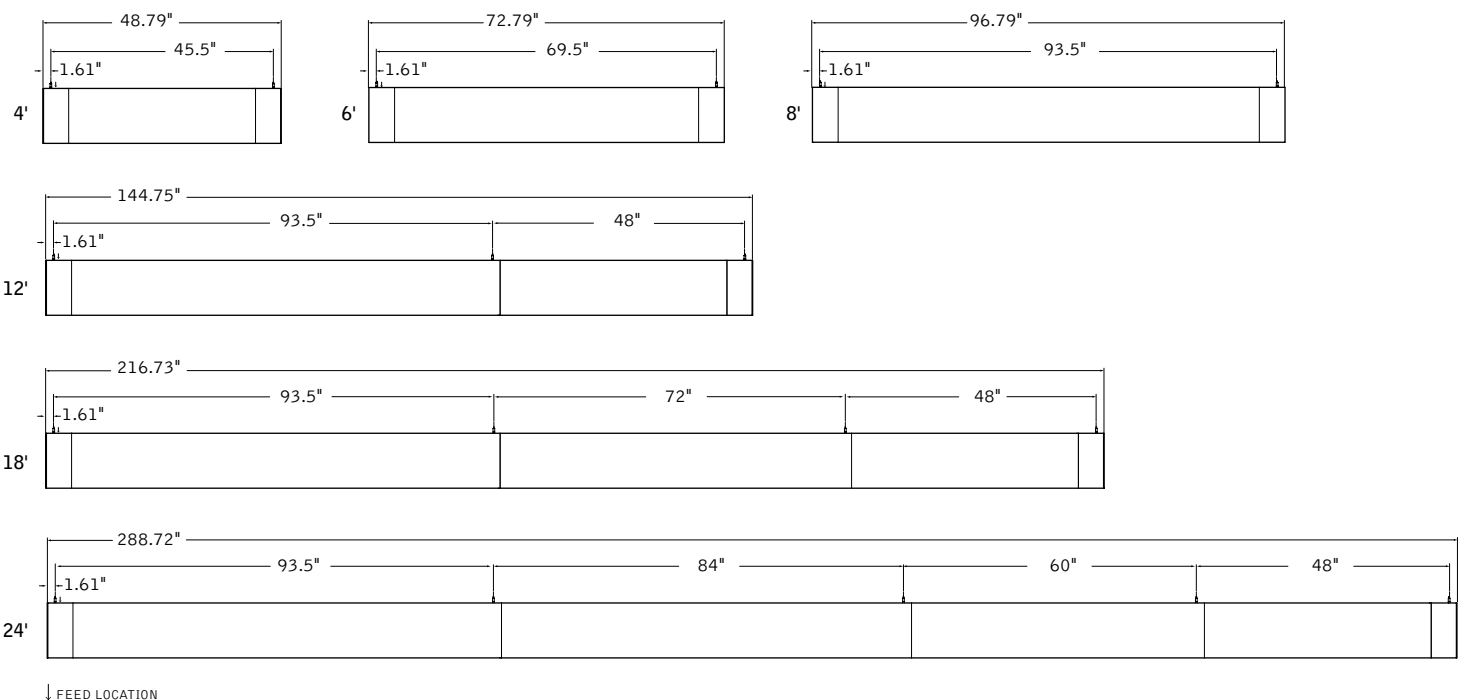

Acoustic Materials



THE NATURALS (25% SCALE)

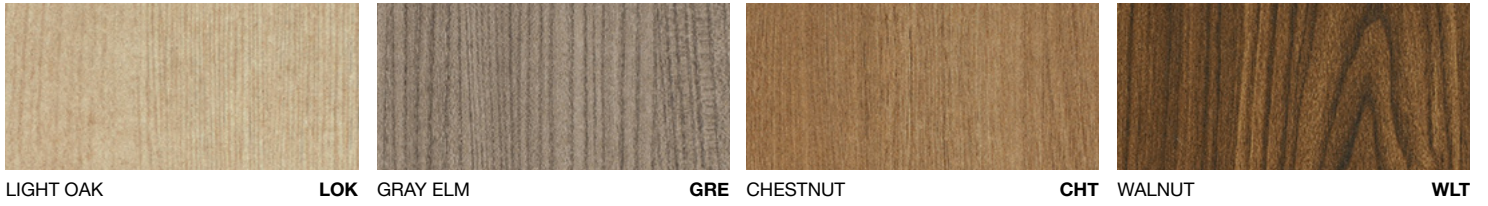

STANDARD PET



PREMIUM PET

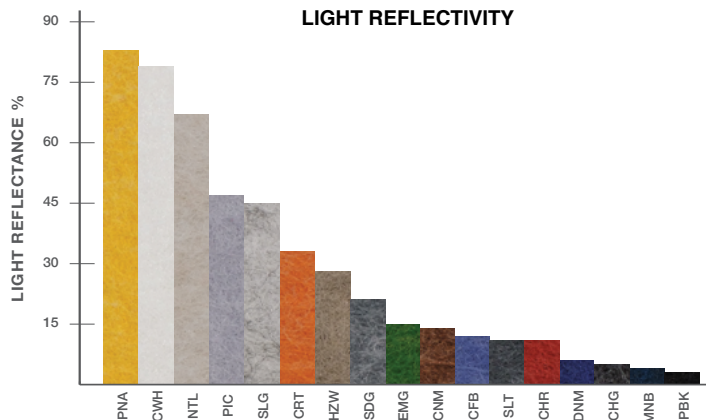

9mm PET Felt
Focal Point, LLC

Final Assembly: Chicago, Illinois, USA
Life Expectancy: 30 Year(s)
End of Life Options: Salvageable/Reusable in its Entirety, Recyclable (100%)

Ingredients:

Polyethylene terephthalate: PET; **N, N'-Ethylene bisstearamide:** Octadecanamide, N,N'-1,2-ethanediylbis-; **Stearic Acid;** Stearic Acid; **Antioxidant 1076:** Benzenepropanoic acid, 3,5-bis(1,1-dimethylethyl)-4-hydroxy-, octadecyl ester; **Antioxidant KY-405:** Benzenamine, 4-(1-methyl-1-phenylethyl) -N-[4-(1-methyl-1-phenylethyl)phenyl]-; **Titanium Dioxide:** Titanium dioxide

Living Building Challenge Criteria: Compliant

I-13 Red List:

- LBC Red List Free
- LBC Red List Approved
- Declared

% Disclosed: 100% at 100ppm
VOC Content: Not Applicable

I-10 Interior Performance: CDPH Standard Method v1.2-2017
I-14 Responsible Sourcing: Not Applicable

FPL-0001
EXP. 01 APR 2025
Original Issue Date: 2020

INTERNATIONAL LIVING FUTURE INSTITUTE™ living-future.org/declare