

ID+ 2.5"

OVERLAP & TRIMLESS LED DOWNLIGHTS

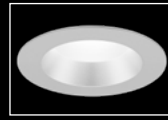

Solite lens

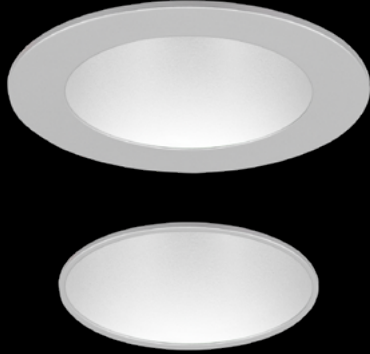

Clear diffuse

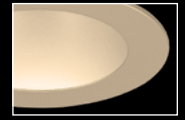

Warm diffuse

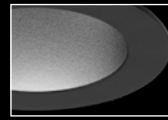

Black



White



Optional painted flanges



Wall Wash companion

DIMENSIONAL DATA

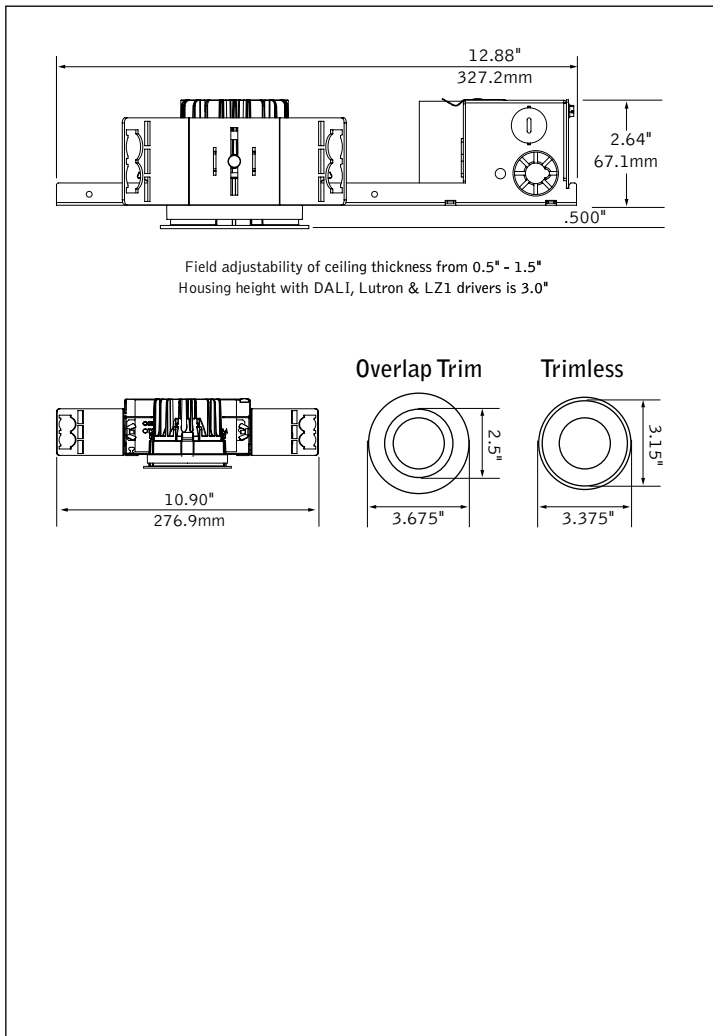

FEATURES

Less than 2.64" low profile housing available.

60° and 75° cut-off reflector options available.

25° to 90° beam spreads support accent lighting, task lighting and general illumination

Solite lens with die-cast trim delivers 70° or 90° beam spread options.

Warm Dim: Lighting that enhances spaces with a warm glow, reminiscent of incandescent or halogen light sources.

PoE compatible: Integrates with Power over Ethernet lighting systems via standard, low-voltage wires.

Configurations available for Title 24 JA8 High Efficacy Lighting compliance.

DISTRIBUTIONS

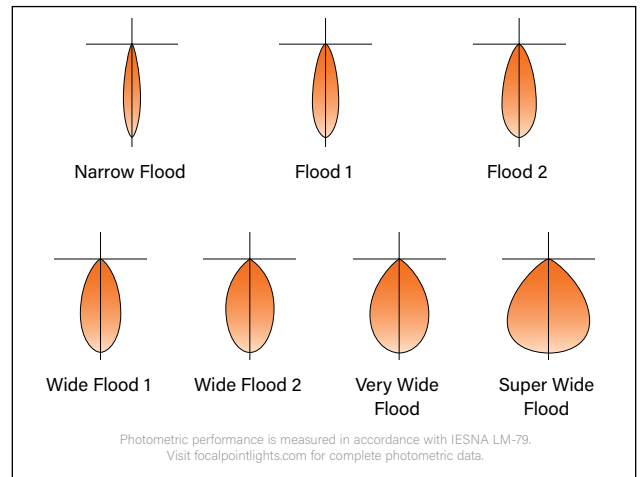

fixture:

project:

HOUSING DETAILS

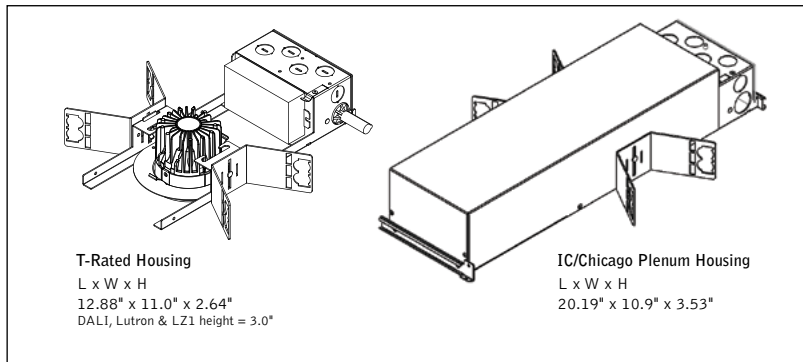

HOUSING SPECIFICATIONS

Construction

Thermally protected housing for new construction applications. Insulation to be kept 3" away from housing. Type IC inherently protected, suitable for direct contact with insulation. Restrictive airflow per ASTM-E283. LC2AT trim is inherently airtight and may be used to obtain airtight rating when used with IC-rated or thermally protected, non-IC (T) housings. Butterfly brackets allow mounting to 1/2" emt. Order bar hangers as an accessory. Die-cast aluminum heat sink designed for maximum thermal dissipation. Die-formed housing and integral junction box with (7) 1/2" pry outs. Accommodates ceiling thicknesses up to 0.5" standard, field adjustable up to 1.5" thickness. Fixture will not exceed 5 lb.

Electrical

Choice of constant current dimming drivers. Power factor > .9 typical. PoE compatible: Integrates with Power over Ethernet lighting systems via standard, low-voltage wires.

Emergency

Above ceiling access required, overlap trim only. Emergency output - 7W for 90 minutes. Maximum mounting height: Clear Diffuse & White: 17.2ft. Black & Warm Diffuse: 15.5ft.

Labels

UL and cUL Listed. Suitable for Dry, Damp or Wet Locations, indoor use only. Specify Outdoor rated (OD) for outdoor recessed ceiling applications. Configurations available for Title 24 JA8 compliance, consult the JA8 High Efficacy Lighting Reference Guide for options. JA8 factory option must be specified to ensure Title 24 JA8 compliance.

Lumen Maintenance

Reported: L70 at >55,000 hours Calculated: L70 at 204,000 hours
L90 at >55,000 hours L90 at 59,000 hours

Derived from EPA TM-21 calculator. Based on typical conditions, consult factory for additional data.

Reliability

At Focal Point, our products are designed to stand the test of time. Each luminaire is engineered using superior components, manufactured with the utmost care and rigorously tested. Contact us for reliability data.

Warranty

LED System rated for operation in ambient environments up to 25°C. 5-year limited warranty. Fixture with Outdoor rated option must be installed in a covered ceiling and is warranted for operation in ambient environments between -20°C to +40°C.

TRIM & LED SPECIFICATIONS

LED System

Proprietary array incorporates premium LEDs on a robust platform. May be specified in 2700K, 3000K, 3500K or 4000K, or Warm Dimming (2700K-1800K and 3000K-1800K), CRI>80, >90 or 97. Color accuracy within 2 SDCM (Warm Dimming from 3-5 SDCM). Aluminum heat sink provides appropriate thermal management.

Aesthetics

Die-cast aluminum trims. Overlap trims are self-flanged.

Optics

60-degree or 75-degree cut-off to light source and its image.

Optic	Cut-Off Degree	Trim Type	Distribution Beam Spread				Spacing Criteria			
			NFL	FL1	FL2	WFL1	WFL2	VWFL	SWFL	
DNS	60°	Overlap	20° 0.36	33° 0.54	42° 0.68	52° 0.80	64° 0.92	-	-	
		Trimless	21° 0.38	33° 0.54	43° 0.68	51° 0.78	62° 0.88	-	-	
DSS	75°	Overlap	-	-	-	52° 0.86	61° 0.88	70° 1.02	81° 1.14	
		Trimless	-	-	-	52° 0.84	65° 0.90	69° 0.98	89° 1.26	

PERFORMANCE TABLE - see page 3.

Focal Point LLC reserves the right to change specifications for product improvement without notification.

HOUSING ORDERING

	FLC2D	FLC2D
Housing Series	FLC2D	
ID+ 2.5" Round		
Trim Type		
Round Overlap	RDO	
Round Trimless	RDT	
Color Options		
Standard White, 80 & 90 CRI	SW	
High 97 CRI	HC	
Warm Dim	WDM	
<small>(900L only. UNV, LV & EMR not available.)</small>		
Lumen Output		
500 Lumen (L1, LD1 & LVN only)	500L	
700 Lumen (Not available with LFP or LH1)	700L	
900 Lumen (Not available with LFP or LH1)	900L	
1100 Lumen	1100L	
1300 Lumen	1300L	
1500 Lumen	1500L	
1700 Lumen	1700L	
1900 Lumen (L1, LD1 & LH1 only)	1900L	
Voltage		
120/277 Volt	UNV	
<small>(IC housing: SW & HC: 1500L max. T & TW housings: SW 1100L max, HC: 900L max.)</small>		
120V	120	
277V	277	
Low Voltage		
LV	LV	
<small>(IC housing: SW & HC: 1500L max. T & TW housings: SW 1100L max, HC: 900L max.)</small>		
Control System & Dimming Level		
0-10V <1% Dimming	LZ1	
0-10V - 1% Dimming	L11	
0-10V - 10% Dimming	LD1	
Low Voltage, PoE Compatible		
<small>(No driver. Not available with EMR. LV voltage only.)</small>		
Forward Phase (120V only)		
Lutron Hi-Lume EcoSystem (LDE1) - 1% Dimming	LFP	
DALI <1% Dimming	LH1	
DALI - 1% Dimming	DZ1	
	D11	
Housing Type		
IC Rated / Airtight (1500L max.)	IC	
Thermally Protected, Non-IC	T	
Thermally Protected, Non-IC Wood	TW	
<small>(Trimless only. Wood kit required)</small>		
Factory Options		
Bar Hangers	BH	
Chicago Plenum	CP	
Emergency Battery -Remote test switch	EMR	
<small>(Overlap trim & T Housing only. Above ceiling access.)</small>		
Outdoor Rated		
<small>(LD1 driver and T-rated housing only. Not available with CP or EMR. See dimming performance table on page 3.)</small>		
Title 24 / JA8 Compliant		
<small>(Consult JA8 Reference Guide for available options.)</small>		
TRIM & LED MODULE		
Aperture		
2.5" Round Reflector	LC2	
2.5" Round Airtight Reflector	LC2AT	
Trim Type		
Round Overlap	RDO	
Round Trimless	RDT	
Lumen Output		
<small>Trim & housing output must match. See options above.</small>		
Color Temperature		
<small>(Add 9 for 90 CRI or H for 97 CRI. Leave blank for 80 CRI. Examples: 2700K, 97 CRI = H27K. 2700K, 80 CRI = 27K.)</small>		
2700K, 80/90/97+ CRI	_27K	
3000K, 80/90/97+ CRI	_30K	
3500K, 80/90/97+ CRI	_35K	
4000K, 80/90/97+ CRI	_40K	
Warm Dim: 2700-1800K, 90+ CRI	92718W	
Warm Dim: 3000-1800K, 90+ CRI	93018W	
Optic		
Short Cone with 60° cut-off	DNS	
Super Short Cone with Solite Lens 75° cut-off	DSS	
Distribution		
Narrow Flood (DNS only)	NFL	
Flood (DNS only)	FL1	
Flood (DNS only)	FL2	
Wide Flood	WFL1	
Wide Flood	WFL2	
Very Wide Flood (DSS only)	VWFL	
Super Wide Flood (DSS only)	SWFL	
Finish		
Clear Diffuse	CD	
Warm Diffuse	WD	
Black	BK	
White	WH	
Optional Flange Finish		
<small>(Overlap CD & WD finish only. For matching finishes leave blank.)</small>		
Black Painted	BP	
White Painted	WP	
Factory Options		
Title 24 / JA8 Compliant (Trim & housing must match.)	JA8	
ACCESSORIES		
Trimless Wood Ceiling Installation Kit	LC2- WOOD-KIT	
<small>(One kit recommended per 10 downlights)</small>		

2.5" ROUND DOWNLIGHT PERFORMANCE TABLE

Lumen Output	Delivered Lumens	System Watts	LPW
500L	513	6	86
700L	756	8.2	92
 900L	880	14.6	60
900L	929	9.9	94
1100L	1139	11.9	96
1300L	1354	16.2	84
1500L	1527	18.1	84
1700L	1746	20.7	84
1900L	1949	23.3	84

Based on Overlap, Short cone, 3500K, 80 CRI, Flood 2, Clear Diffuse. WDM based on 3000 - 1800K, 90 CRI. Delivered lumen output may vary +/- 5%. Actual wattage may vary +/- 5%

OUTDOOR RATED (OD) DRIVER DIMMING PERFORMANCE TABLE

Lumen Output	Minimum Dimming Level
500L	25%
700L	17%
900L	13%
1100L	10%
1300L	10%
1500L	10%
1700L	10%
1900L	10%

2.5" ROUND DOWNLIGHT LUMEN MULTIPLIER TABLE

Color Temperature & CRI

Trim Type	Optic	Color Temperature & CRI	Multiplier
ALL	ALL	2700K 80+ CRI [27K]	0.92
		2700K 90+ CRI [927K]	0.79
		2700K 97 CRI [H27K]	0.67
		3000K 80+ CRI [30K]	0.98
		3000K 90+ CRI [930K]	0.83
		3000K 97 CRI [H30K]	0.72
		3500K 80+ CRI [35K]	1.00
		3500K 90+ CRI [935K]	0.82
		3500K 97 CRI [H35K]	0.73
		4000K 80+ CRI [40K]	1.01
		4000K 90+ CRI [940K]	0.84
		4000K 97 CRI [H40K]	0.76
2700-1800K 90+ CRI [92718K]	0.93		
3000-1800K 90+ CRI [93018K]	0.98		

Distribution

Trim Type	Optic	Distribution	Multiplier
Round Trimless [RDT]	Short Cone with 60° cut-off [DNS]	Narrow Flood [NFL]	1.05
		Flood 1 [FL1]	0.99
		Flood 2 [FL2]	1.03
		Wide Flood 1 [WFL1]	1.00
		Wide Flood 2 [WFL2]	0.91
	Super Short Cone with Solite Lens with 75° cut-off [DSS]	Wide Flood 1 [WFL1]	1.07
		Wide Flood 2 [WFL2]	0.82
		Very Wide Flood [VWFL]	0.85
		Super Wide Flood [SWFL]	0.75
		Round Overlap [RDO]	Short Cone with 60° cut-off [DNS]
Flood 1 [FL1]	0.99		
Flood 2 [FL2]	1.03		
Wide Flood 1 [WFL1]	1.00		
Wide Flood 2 [WFL2]	0.91		
Super Short Cone with Solite Lens with 75° cut-off [DSS]	Wide Flood 1 [WFL1]		1.07
	Wide Flood 2 [WFL2]		0.82
	Very Wide Flood [VWFL]		0.85
	Super Wide Flood [SWFL]		0.75

How To Use Lumen Multipliers

Formula:
 (Lumen Output Value) x
 (Color Temperature & CRI) x
 (Distribution) x
 (Color)

Example:

LC2-RDO-SW-1100L-935K-DNS-FL1-WH

(1100) x (0.83) x (0.99) x (1.08) ≈ 976lm
 (estimated delivered lumens)

Color

Trim Type	Optic	Color	Multiplier
ALL	Short Cone with 60° cut-off [DNS]	Clear Diffuse [CD]	1.00
		Warm Diffuse [WD]	0.99
		White [WH]	1.08
		Black [BK]	0.90
		Super Short Cone with Solite Lens with 75° cut-off [DSS]	1.00
	Super Short Cone with Solite Lens with 75° cut-off [DSS]	Warm Diffuse [WD]	0.98
		White [WH]	1.08
		Black [BK]	0.90

Multiplier charts are provided to aid with estimation of lumen levels across options. Apply multipliers against ordered Lumen Output to estimate Delivered Lumens. An estimation should make use of all tables through consecutive application of three multipliers. Refer to IES files for most accurate photometric information.