

ID+ 4.5" x 4.5"

LED ADJUSTABLE DOWNLIGHT

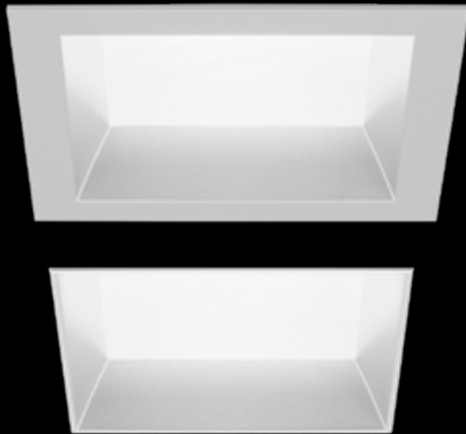

FOCAL POINT®



0°-15° tilt Spot detail



15°-30° tilt Spot detail



25°-40° tilt Spot detail



Clear Diffuse

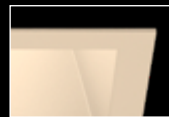

Warm Diffuse



White

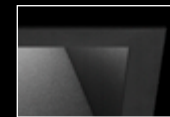

Black



Clear Diffuse & White flange



The Naturals collection - Grey Elm shown

DIMENSIONAL DATA

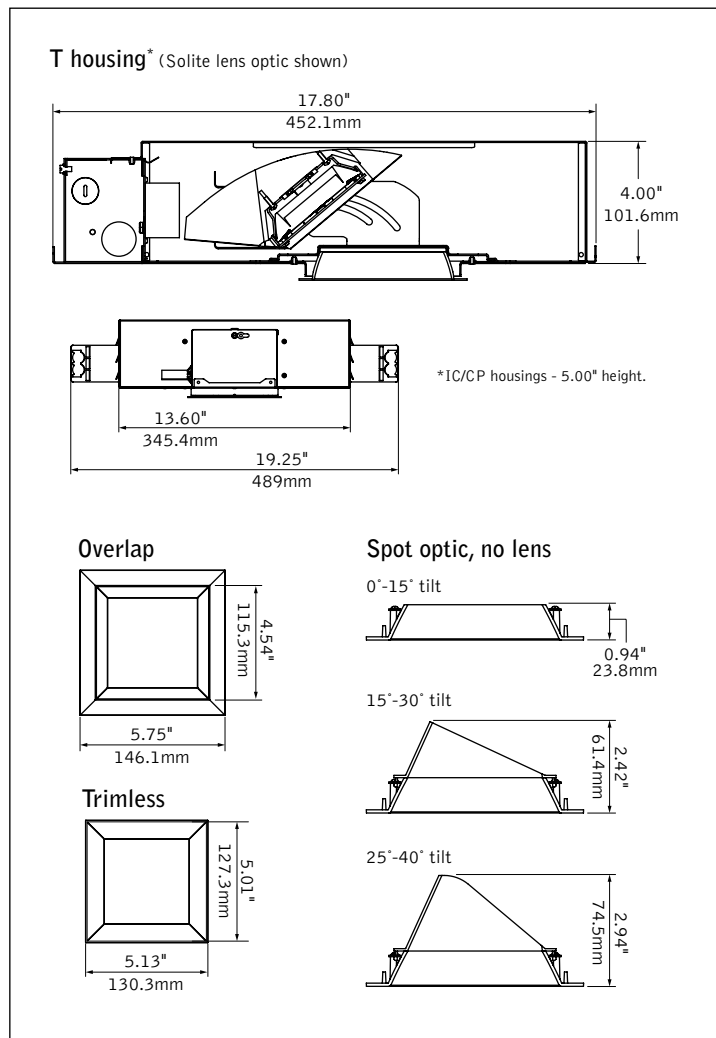

FEATURES

12° beam is ideal for art and object accenting, additional beamreads up to 90° complement any application.

Allows for aiming with locking 40° vertical tilt and 364° rotation of light module.

Overlap and trimless options.

Warm Dim: Lighting that enhances spaces with a warm glow, reminiscent of incandescent or halogen light sources.

PoE compatible: Integrates with Power over Ethernet lighting systems via standard, low-voltage wires.

Outdoor rating permits use in outdoor covered ceiling applications.

Available with The Naturals, a series of finishes that exude biophilic beauty.

DISTRIBUTIONS

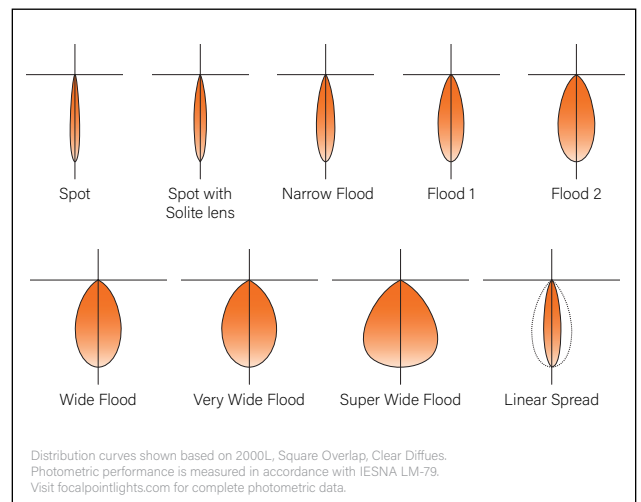

fixture:

project:

HOUSING DETAILS

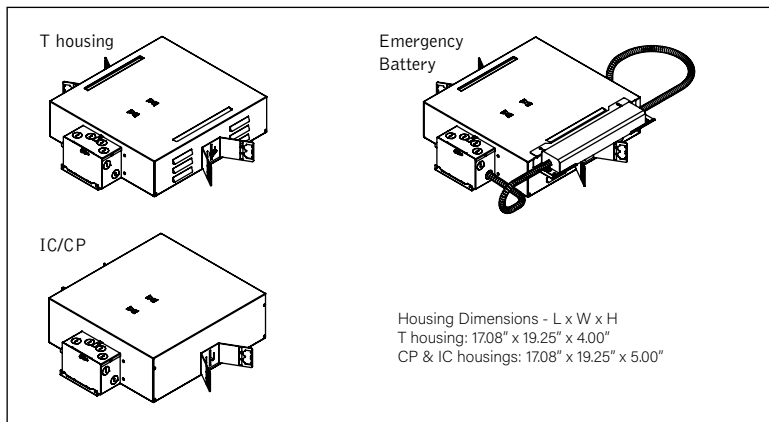

HOUSING SPECIFICATIONS

LED System

Proprietary LED module with single light emitting source. May be specified in 2700K, 3000K, 3500K or 4000K in CRI>80, CRI>90, or CRI>97. Color accuracy within 2 SDCM. Warm Dim within 3-5 SDCM. Aluminum heat sink provides appropriate thermal management.

Construction

T housing for new construction applications. Insulation to be kept 3" away from housing. Type IC inherently protected, suitable for direct contact with insulation. Butterfly brackets allow mounting to 1/2" emt. Order bar hangers as an accessory. Cast aluminum heat sink designed for maximum thermal dissipation. Die-formed housing and integral junction box with (7) 1/2" pry outs. UL & cUL listed for (8) #12 AWG (4 in, 4 out) 90°C conductors and feed through-branch wiring. Accommodates ceiling thicknesses from 0.5"-1.85" standard. For thicker ceiling consult factory. Fixture will not exceed 15lb.

Adjustment

Manual locking 40° vertical tilt and 364° rotation of light module.

Electrical

Choice of constant current dimming drivers. Power factor > .9 typical. PoE compatible: Integrates with Power over Ethernet lighting systems via standard, low-voltage wires.

Emergency Battery

Emergency output—7W for 90 minutes. Maximum mounting height: 19ft. For applications requiring higher than 2000L consult factory for maximum mounting height. Above ceiling access only.

Labels

UL and cUL listed. Suitable for Dry, Damp or Wet Locations indoor use only. Wet Location Solite lens options only. Specify Outdoor rated (OD) for outdoor recessed ceiling applications.

Lumen Maintenance

Reported: L70 at >55,000 hours Calculated: L70 at 204,000 hours
 Reported: L90 at >55,000 hours Calculated: L90 at 59,000 hours
 Derived from EPA TM-21 calculator. Based on typical conditions, consult factory for additional data.

Reliability

At Focal Point, our products are designed to stand the test of time. Each luminaire is engineered using superior components, manufactured with the utmost care and rigorously tested. Contact us for reliability data.

Warranty

LED System rated for operation in ambient environments up to 40°C. 5-year limited warranty.

TRIM SPECIFICATIONS

Aesthetics

Parabolic reflector cone ensures glare free optics. Reflector is die-cast aluminum. Torsion springs pull trim tight to the ceiling with no visible fasteners within the trim. Trims are self-flanged. Non-painted trim matches reflector finish. White or Black painted flange may also be specified. Spot distribution is offered with Solite lens and No lens options. No lens options with greater than 15° vertical tilt, feature a shroud to conceal internal components and maintain a premium aesthetic while providing a narrow spot distribution. The Naturals: 100% low VOC vinyl.

Optics

75-degree cut-off to light source and its image.

Lumen range	Distribution Beam Spread								
	SP	SP with Solite	NFL	FL1	FL2	WFL	VWFL	SWFL	LS
1000 - 2000	12.4° 0.22	17.8° 0.28	24.6° 0.40	31.8° 0.52	45.7° 0.74	59.5° 0.88	71.7° 1.00	86.4° 1.26	18.5° x 51.2° 0.34 x 0.80
2500 - 4000	-	-	21.2° 0.40	34.8° 0.58	43.0° 0.70	62.0° 0.90	72.5° 1.02	89.4° 1.24	25.3° x 54.5° 0.46 x 0.84

PERFORMANCE CHART

See Page 3

Focal Point LLC reserves the right to change specifications for product improvement without notification.

HOUSING ORDERING

Housing Series	FLCS44
ID+ 4.5" Square Housing	FLCS44
Trim Type	
Square Overlap	SO
Square Trimless	ST
Lumen Output	
1000 Lumens	1000L
1500 Lumens	1500L
2000 Lumens	2000L
2500 Lumens	2500L
3000 Lumens	3000L
3500 Lumens	3500L
4000 Lumens	4000L
<small>(Not available with 97+ CRI)</small>	
Color Temperature	
<small>(Add 9 for 90 CRI or H for 97 CRI. Leave blank for 80 CRI. CRI 97: T & TW housing 3500L max, IC housing 2000L.)</small>	
2700K, 80/90/97+ CRI	_27K
3000K, 80/90/97+ CRI	_30K
3500K, 80/90/97+ CRI	_35K
4000K, 80/90/97+ CRI	_40K
Warm Dim: 2700-1800K, 90+ CRI*	92718W
Warm Dim: 3000-1800K, 90+ CRI*	93018W
<small>*1000L, 1500L, 2500L only. IC, UNV or LV available with 1000L & 1500L only.)</small>	

Distribution

Spot (2000L max.)	SP
Narrow Flood	NFL
Flood 1	FL1
Flood 2	FL2
Wide Flood	WFL
Very Wide Flood	VWFL
Super Wide Flood	SWFL
Linear Spread Lens	LS

Voltage

UNV 120/277 Volt	UNV
<small>(L11 & LD1 2500L max., LZ1, DZ1, D11 & LFP 2000L max., LH1 1500L max.)</small>	
120 Volt	120
277 Volt	277
Low Voltage	LV
<small>(2500L max.)</small>	

Driver

0-10V - 0% Dimming	LZ1
0-10V - 1% Dimming	L11
0-10V - 10% Dimming	LD1
Forward Phase (120V only)	LFP
Low Voltage, PoE Compatible	LVN
<small>(No driver, LV Voltage only. Not available with EM.)</small>	
Lutron Hi-Lume EcoSystem (LDE1) - 1% Dimming	LH1
DALI - 0% Dimming	DZ1
DALI - 1% Dimming	D11

Housing Type

IC rated	IC
<small>(L11, LD1 & LVN 2500L max. LZ1, DZ1, D11 & LFP 2000L max. LH1 1500L max.)</small>	
Non-IC	T
<small>(LZ1, LH1, DZ1, D11 3000L max. LFP 3500L max.)</small>	
Non-IC Wood	TW
<small>(ST only, requires Trimless Wood Kit.)</small>	

Factory Options

Bar Hangers	BH
Chicago Plenum	CP
Emergency Battery with Remote Test Switch	EMR
<small>(T housing only. Not available with Warm Dim. Above ceiling access only.)</small>	
Outdoor Rated	OD
<small>(LD1 driver only, IC housing 2500L max. Solite lens optic only. See dimming Performance Chart on page 3.)</small>	

TRIM ORDERING

Aperture

4.5" Square Aperture LCS44

Trim Type

Square Die-Cast Overlap	SDO
Square Die-Cast Trimless	SdT

Optic

<small>(SP distribution available with all Optic options, all other distributions SL only)</small>	
Solite Lens	SL
Spot Optic, no lens, for 0°-15° tilt	SP00
Spot Optic, no lens, for 15°-30° tilt	SP30
Spot Optic, no lens, for 25°-40° tilt	SP40

Color

<small>(See finishes page for The Naturals options)</small>	
Clear Diffuse	CD
Warm Diffuse	WD
Black	BK
White	WH



Optional Flange Finish

<small>(Overlap CD & WD finish only.) (For matching finishes leave blank)</small>	
Black Painted	BP
White Painted	WP

ACCESSORIES

Distribution Kit	FLCS44-
<small>(Order kits to change distribution in field. Add Distribution code from above. Example FLCS44-SP)</small>	
Spot Optic Title Kit	KIT-
<small>(Add code for desired title degree - 15°-30° = SP30, 25°-40° = SP40, Both = SPB)</small>	
Trimless Wood Kit	FLCS44- WOOD-KIT
<small>(One kit suggested per 10 units)</small>	

4.5" SQUARE ADJUSTABLE DOWNLIGHT PERFORMANCE TABLE

Lumen Output	Delivered Lumens	System Watts	LPW
1000L	1073	11.5	93
 1000L	871	14.6	60
1500L	1553	16.8	93
 1500L	1571	23.5	67
2000L	2086	23.7	88
2500L	2415	27.2	89
 2500L	2381	37.2	64
3000L	2897	32.5	89
3500L	3337	38.1	88
4000L	3878	44.2	88

Based on SL optic, 3500K, 80CRI, Narrow Flood, Clear Diffuse. Warm Dim based on 3000 - 1800K, 90 CRI. Overlap and trimless offer identical performance. Delivered lumen output may vary +/- 5%. Actual wattage may vary +/- 5%.

4.5" SQUARE ADJUSTABLE DOWNLIGHT CBCP CHART

Lumen Output	Distribution	Beamspread	Center Beam Candlepower (CBCP)
2000L	SP	12.4°	30912
	SP with Solite lens	17.8°	16934
	NFL	24.6°	8802
	FL1	31.8°	5039
	FL2	45.7°	2823
	WFL	59.5°	1805
	VWFL	71.7°	1386
	SWFL	86.4°	1018
	LS	18.5° x 51.2°	5499

OUTDOOR RATED (OD) DRIVER DIMMING PERFORMANCE TABLE

Lumen Output	Minimum Dimming Level
1000L	13%
1500L	10%
2000L	10%
2500L	10%
3000L	10%
3500L	10%
4000L	10%

4.5" SQUARE DOWNLIGHT LUMEN MULTIPLIER TABLE

Color Temperature & CRI¹

Color Options	Lumen Output	Color Temperature & CRI	Multiplier
Standard White	All Outputs	2700K, 80+ CRI [27K]	0.92
		2700K, 90+ CRI [927K]	0.79
		2700K, 97+ CRI [9727K]	0.67
		3000K, 80+ CRI [30K]	0.98
		3000K, 90+ CRI [930K]	0.83
		3000K, 97+ CRI [9730K]	0.72
		3500K, 80+ CRI [35K]	1.00
		3500K, 90+ CRI [935K]	0.82
		3500K, 97+ CRI [9735K]	0.73
		4000K, 80+ CRI [40K]	1.01
		4000K, 90+ CRI [940K]	0.84
		4000K, 97+ CRI [9740K]	0.76
 Warm Dim	1000L	2700-1800K, 90+ CRI [92718W]	0.77
		3000-1800K, 90+ CRI [93018W]	0.87
	1500L	2700-1800K, 90+ CRI [92718W]	0.82
		3000-1800K, 90+ CRI [93018W]	1.05
	2500L	2700-1800K, 90+ CRI [92718W]	0.78
		3000-1800K, 90+ CRI [93018W]	0.95

Color³

Trim	Color	Multiplier
All	Clear Diffuse [CD]	1.00
	Warm Diffuse [WD]	0.98
	White [WH]	1.02
	Black [BK]	0.95
	Woven Linen [WLN]	0.93
	Walnut [WLT]	0.45
	Gray Elm [GRE]	0.72
	Chestnut [CHT]	0.75
	Light Oak [LOK]	0.90

Distribution²

Trim	Distribution	Square Overlap Multiplier		Square Trimless Multiplier	
		1000L - 2000L	2500L - 4000L	1000L - 2000L	2500L - 4000L
Square Overlap	Spot [SP]	1.11	—	1.11	—
	Spot with Solite lens [SP]	1.09	—	1.09	—
	Narrow Flood [NFL]	1.04	0.97	1.04	0.97
	Flood 1 [FL1]	1.01	0.93	1.01	0.93
	Flood 2 [FL2]	1.03	0.98	1.03	0.98
	Wide Flood [WFL]	0.98	0.91	0.98	0.91
	Very Wide Flood [VWFL]	0.98	0.88	0.98	0.88
	Super Wide Flood [SWFL]	0.94	0.85	0.94	0.85
	Linear Spread [LS]	1.00	0.93	1.00	0.93

How To Use Lumen Multipliers

Formula:

(Lumen Output Value) x (Color Temperature & CRI¹) x (Distribution²) x (Color³)

Example:

FLCS44-SO-2000L-935K-FL1-SDO-WH
 (2000) x (0.82) x (1.01) x (1.02) ≈ 1690lm (estimated delivered lumens)

Multiplier charts are provided to aid with estimation of lumen levels across options. Apply multipliers against ordered Lumen Output to estimate Delivered Lumens. An estimation should make use of all tables through consecutive application of three multipliers. Refer to IES files for most accurate photometric information.

Finishes



STANDARD FINISHES



WHITE WH BLACK BK CLEAR DIFFUSE CD WARM DIFFUSE WD

THE NATURALS (25% SCALE)



LIGHT OAK LOK GRAY ELM GRE CHESTNUT CHT WALNUT WLT WOVEN LINEN WLN