

ID+ 4.5"

LED ADJUSTABLE DOWNLIGHT



0°-15° tilt Spot detail



15°-30° tilt Spot detail

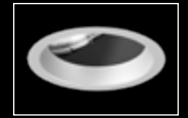

25°-40° tilt Spot detail



Clear Diffuse



Warm Diffuse



White



Black



Clear Diffuse & White flange



Warm Diffuse & White flange

DIMENSIONAL DATA

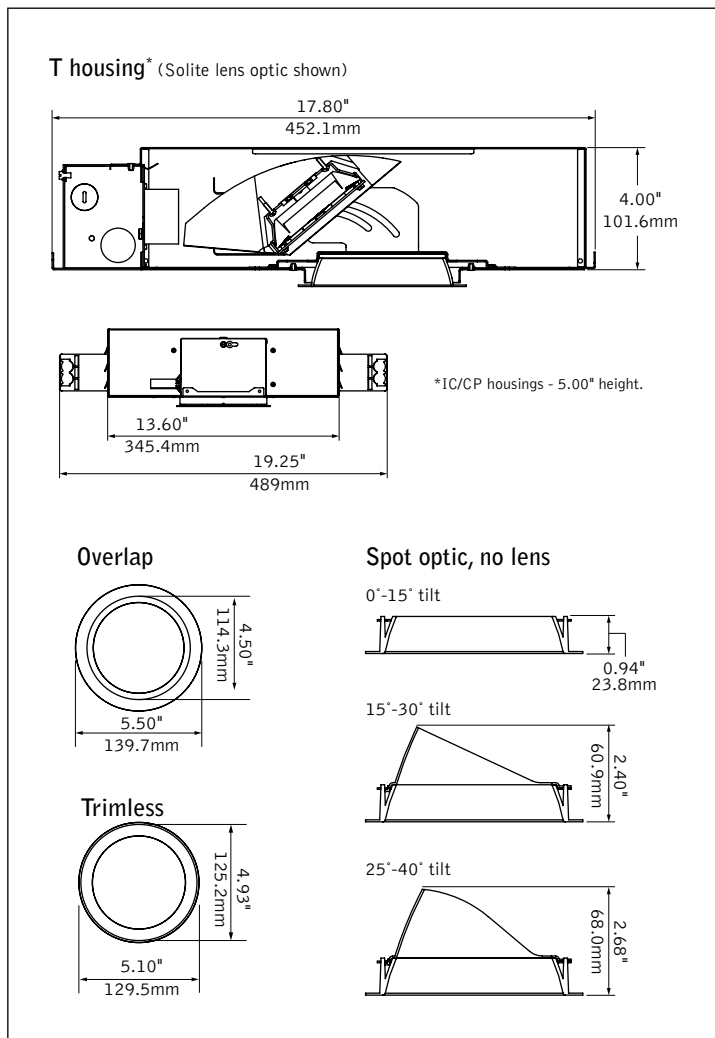

FEATURES

12° beam is ideal for art and object accenting, additional beamreads up to 90° complement any application.

Allows for aiming with locking 40° vertical tilt and 364° rotation of light module.

Overlap and trimless options.

Warm Dim: Lighting that enhances spaces with a warm glow, reminiscent of incandescent or halogen light sources.

PoE compatible: Integrates with Power over Ethernet lighting systems via standard, low-voltage wires.

Outdoor rating permits use in outdoor covered ceiling applications.

DISTRIBUTIONS

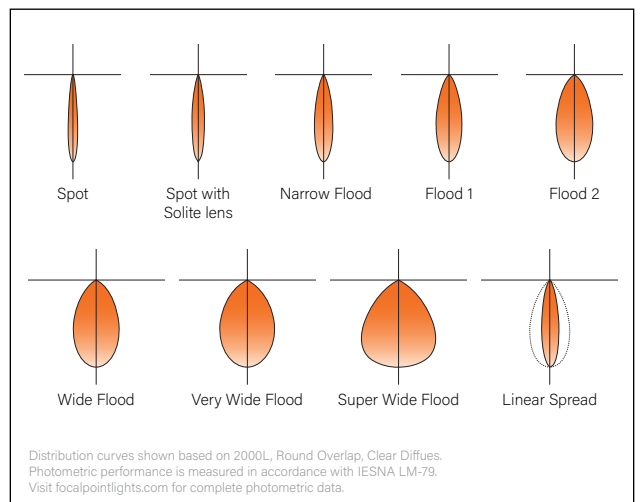

fixture:

project:

HOUSING DETAILS

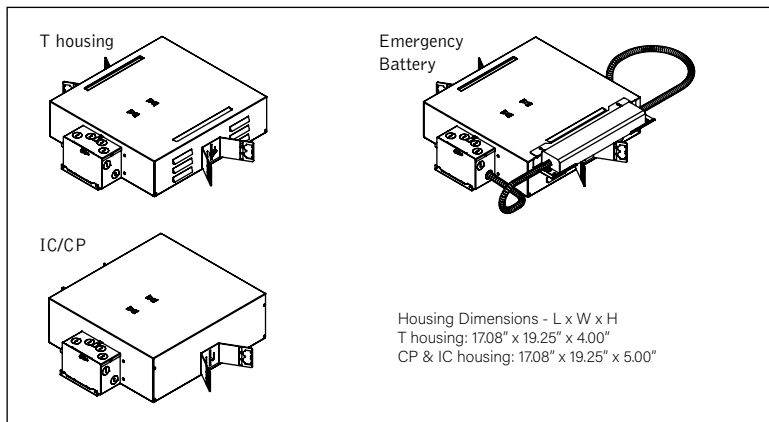

HOUSING SPECIFICATIONS

LED System

Proprietary LED module with single light emitting source. May be specified in 2700K, 3000K, 3500K or 4000K in CRI>80, CRI>90, or CRI>97. Color accuracy within 2 SDCM. Warm Dim within 3-5 SDCM. Aluminum heat sink provides appropriate thermal management.

Construction

T housing for new construction applications. Insulation to be kept 3" away from housing. Type IC inherently protected, suitable for direct contact with insulation. Butterfly brackets allow mounting to 1/2" emt. Order bar hangers as an accessory. Cast aluminum heat sink designed for maximum thermal dissipation. Die-formed housing and integral junction box with (7) 1/2" pry outs. UL & cUL listed for (8) #12 AWG (4 in, 4 out) 90°C conductors and feed through-branch wiring. Accommodates ceiling thicknesses from 0.5"-1.5" standard. For thicker ceiling consult factory. Fixture will not exceed 15lb.

Adjustment

Manual locking 40° vertical tilt and 364° rotation of light module.

Electrical

Choice of constant current dimming drivers. Power factor > .9 typical. PoE compatible: Integrates with Power over Ethernet lighting systems via standard, low-voltage wires.

Emergency Battery

Emergency output—7W for 90 minutes. Maximum mounting height: 19ft. For applications requiring higher than 2000L consult factory for maximum mounting height. Above ceiling access only.

Labels

UL and cUL listed. Suitable for Dry, Damp or Wet Locations indoor use only. Wet Location Solite lens options only. Specify Outdoor rated (OD) for outdoor recessed ceiling applications.

Lumen Maintenance

Reported: L70 at >55,000 hours Calculated: L70 at 204,000 hours
 Reported: L90 at >55,000 hours Calculated: L90 at 59,000 hours
 Derived from EPA TM-21 calculator. Based on typical conditions, consult factory for additional data.

Reliability

At Focal Point, our products are designed to stand the test of time. Each luminaire is engineered using superior components, manufactured with the utmost care and rigorously tested. Contact us for reliability data.

Warranty

LED System rated for operation in ambient environments up to 25°C. 5-year limited warranty.

TRIM SPECIFICATIONS

Aesthetics

Parabolic reflector cone ensures glare free optics. Reflector is die-cast aluminum. Torsion springs pull trim tight to the ceiling with no visible fasteners within the trim. Trim is inherently air tight with Solite lens. Trims are self-flanged. Non-painted trim matches reflector finish. White or Black painted flange may also be specified. Spot distribution is offered with Solite lens and No lens options. No lens options with greater than 15° vertical tilt, feature a shroud to conceal internal components and maintain a premium aesthetic while providing a narrow spot distribution.

Optics

75-degree cut-off to light source and its image.

Lumen range	Distribution Beam Spread								
	Spacing Criteria								
	SP	SP with Solite	NFL	FL1	FL2	WFL	VWFL	SWFL	LS
1000 - 2000	12.6° 0.22	17.7° 0.32	24.0° 0.42	33.6° 0.56	48.0° 0.76	60.4° 0.88	72.2° 1.00	86.4° 1.24	22.8° x 51.8° 0.42 x 0.80
2500 - 4000	-	-	24.9° 0.42	37.1° 0.60	44.1° 0.70	56.7° 0.86	74.2° 1.04	87.4° 1.26	28.6° x 53.9° 0.52 x 0.84

PERFORMANCE CHART

See Page 3

Focal Point LLC reserves the right to change specifications for product improvement without notification.

HOUSING ORDERING

Housing Series

ID+ 4.5" Round Housing FLCS4

Trim Type

Round Overlap RO
 Round Trimless RT

Lumen Output

1000 Lumens 1000L
 1500 Lumens 1500L
 2000 Lumens 2000L
 2500 Lumens 2500L
 3000 Lumens 3000L
 3500 Lumens 3500L
 4000 Lumens 4000L
 (Not available with 97+ CRI)

(Add 9 for 90 CRI or H for 97 CRI. Leave blank for 80 CRI. CRI 97: T & TW housing 3500L max, IC housing 2000L.)

Color Temperature

2700K, 80/90/97+ CRI _27K
 3000K, 80/90/97+ CRI _30K
 3500K, 80/90/97+ CRI _35K
 4000K, 80/90/97+ CRI _40K
 Warm Dim: 2700-1800K, 90+ CRI* 92718W
 Warm Dim: 3000-1800K, 90+ CRI* 93018W
 *(1000L, 1500L, 2500L only, IC, UNV or LV available with 1000L & 1500L only)

Distribution

Spot (2000L max.) SP
 Narrow Flood NFL
 Flood 1 FL1
 Flood 2 FL2
 Wide Flood WFL
 Very Wide Flood VWFL
 Super Wide Flood SWFL
 Linear Spread Lens LS

Voltage

UNV 120/277 Volt UNV
 (L11 & LD1 2500L max., LZ1, DZ1, D11, LFP 2000L max., LH1 1500L max.)
 120 Volt 120
 277 Volt 277
 Low Voltage LV
 (2500L max.)

Driver

0-10V - 0% Dimming LZ1
 0-10V - 1% Dimming L11
 0-10V - 10% Dimming LD1
 Forward Phase (120V only) LFP
 Low Voltage, PoE Compatible LVN
 (No driver, LV Voltage only. Not available with EM.)
 Lutron Hi-Lume EcoSystem (LDE1) - 1% Dimming LH1
 DALI - 0% Dimming DZ1
 DALI - 1% Dimming D11

Housing Type

IC rated IC
 (L11, LD1 & LVN 2500L max. LZ1, DZ1, D11 & LFP 2000L max., LH1 1500L max.)
 Non-IC T
 (LZ1, LH1, DZ1, D11 3000L max. LFP 3500L max.)
 Non-IC Wood TW
 (RT only, requires Trimless Wood Kit.)

Factory Options

Bar Hangers BH
 Chicago Plenum CP
 Emergency Battery with Remote Test Switch EMR
 (T housing only. Not available with Warm Dim. Above ceiling access only.)
 Outdoor Rated OD
 (LD1 driver only. IC housing 2500L max. Solite lens optic only. See dimming Performance Chart on page 3.)

TRIM ORDERING

Aperture

4.5" Round Aperture LCS4

Trim Type

Round Die-Cast Overlap RDO
 Round Die-Cast Trimless RDT

Optic

(SP distribution available with all Optic options, all other distributions SL only)
 Solite Lens SL
 Spot Optic, no lens, for 0°-15° tilt SP00
 Spot Optic, no lens, for 15°-30° tilt SP30
 Spot Optic, no lens, for 25°-40° tilt SP40

Color

Clear Diffuse CD
 Warm Diffuse WD
 Black BK
 White WH

Optional Flange Finish

(Overlap CD & WD finish only.) (For matching finishes leave blank)
 Black Painted BP
 White Painted WP

ACCESSORIES

Distribution Kit FLCS4-
 (Order kits to change distribution in field. Add Distribution code from above. Example FLCS4-SP)
 Spot Optic Title Kit KIT-
 (Add code for desired title degree - 15°-30° = SP30, 25°-40° = SP40, Both = SPB) FLCS4-
 Trimless Wood Kit FLCS4-
 (One kit suggested per 10 units) WOOD-KIT

4.5" ROUND ADJUSTABLE DOWNLIGHT PERFORMANCE TABLE

Lumen Output	Delivered Lumens	System Watts	LPW
1000L	1042	11.5	91
1000L	847	14.6	58
1500L	1508	16.8	90
1500L	1519	23.5	65
2000L	2025	23.7	85
2500L	2561	27.2	94
2500L	2317	37.1	62
3000L	3073	32.5	95
3500L	3539	38.1	93
4000L	4113	44.3	93

Based on SL optic, 3500K, 80CRI, Narrow Flood, Clear Diffuse. Warm Dim based on 3000 - 1800K, 90 CRI. Overlap and trimless offer identical performance. Delivered lumen output may vary +/- 5%. Actual wattage may vary +/- 5%.

4.5" ROUND ADJUSTABLE DOWNLIGHT CBCP CHART

Lumen Output	Distribution	Beamspread	Center Beam Candlepower (CBCP)
2000L	SP	12.6°	28962
	SP with Solite lens	17.7°	12854
	NFL	24.0°	8035
	FL1	33.6°	4276
	FL2	48.0°	2518
	WFL	60.4°	1719
	VWFL	72.2°	1332
	SWFL	86.4°	985
	LS	22.8° x 51.8°	4327

OUTDOOR RATED (OD) DRIVER DIMMING PERFORMANCE TABLE

Lumen Output	Minimum Dimming Level
1000L	13%
1500L	10%
2000L	10%
2500L	10%
3000L	10%
3500L	10%
4000L	10%

4.5" ROUND DOWNLIGHT LUMEN MULTIPLIER TABLE

Color Temperature & CRI¹

Color Options	Lumen Output	Color Temperature & CRI	Multiplier
Standard White	All Outputs	2700K, 80+ CRI [27K]	0.92
		2700K, 90+ CRI [927K]	0.79
		2700K, 97+ CRI [9272K]	0.67
		3000K, 80+ CRI [30K]	0.98
		3000K, 90+ CRI [930K]	0.83
		3000K, 97+ CRI [9730K]	0.72
		3500K, 80+ CRI [35K]	1.00
		3500K, 90+ CRI [935K]	0.82
		3500K, 97+ CRI [9735K]	0.73
		4000K, 80+ CRI [40K]	1.01
4000K, 90+ CRI [940K]	0.84		
4000K, 97+ CRI [9740K]	0.76		
Warm Dim	1000L	2700-1800K, 90+ CRI [92718W]	0.75
		3000-1800K, 90+ CRI [93018W]	0.85
	1500L	2700-1800K, 90+ CRI [92718W]	0.79
		3000-1800K, 90+ CRI [93018W]	1.01
	2500L	2700-1800K, 90+ CRI [92718W]	0.76
		3000-1800K, 90+ CRI [93018W]	0.93

Color³

Trim	Color	Multiplier
All	Clear Diffuse [CD]	1.00
	Warm Diffuse [WD]	0.98
	White [WH]	1.01
	Black [BK]	0.93

Distribution²

Trim	Distribution	Round Overlap Multiplier		Round Trimless Multiplier	
		1000L - 2000L	2500L - 4000L	1000L - 2000L	2500L - 4000L
Round Overlap	Spot [SP]	1.08	—	1.08	—
	Spot with Solite lens [SP]	1.06	—	1.06	—
	Narrow Flood [NFL]	1.01	1.03	1.01	1.03
	Flood 1 [FL1]	0.98	0.93	0.98	0.93
	Flood 2 [FL2]	1.00	0.98	1.00	0.98
	Wide Flood [WFL]	0.96	0.90	0.96	0.90
	Very Wide Flood [VWFL]	0.93	0.91	0.93	0.91
	Super Wide Flood [SWFL]	0.89	0.88	0.89	0.88
	Linear Spread [LS]	0.98	0.97	0.98	0.97

How To Use Lumen Multipliers

Formula:

(Lumen Output Value) x (Color Temperature & CRI¹) x (Distribution²) x (Color³)

Example:

FLCS4-RO-2000L-935K-FL1-LCS4-RDO-WH
 (2000) x (0.82) x (.98) x (1.01) = 1623lm (estimated delivered lumens)

Multiplier charts are provided to aid with estimation of lumen levels across options. Apply multipliers against ordered Lumen Output to estimate Delivered Lumens. An estimation should make use of all tables through consecutive application of three multipliers. Refer to IES files for most accurate photometric information.

ID+ 4.5" x 4.5"

LED ADJUSTABLE DOWNLIGHT



FOCAL POINT®

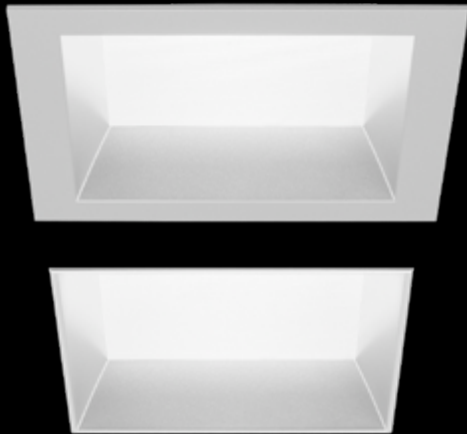

0°-15° tilt Spot detail



15°-30° tilt Spot detail



25°-40° tilt Spot detail



Clear Diffuse

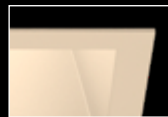

Warm Diffuse



White

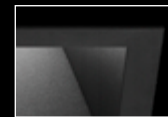

Black



Clear Diffuse & White flange



The Naturals collection - Grey Elm shown

DIMENSIONAL DATA

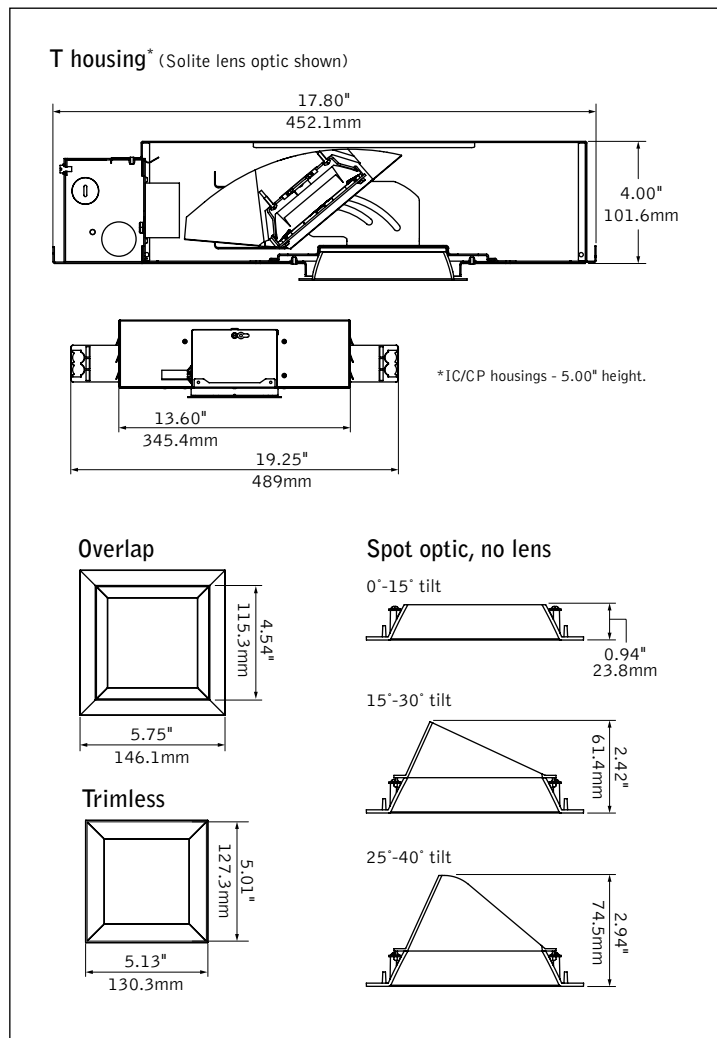

FEATURES

12° beam is ideal for art and object accenting, additional beamreads up to 90° complement any application.

Allows for aiming with locking 40° vertical tilt and 364° rotation of light module.

Overlap and trimless options.

Warm Dim: Lighting that enhances spaces with a warm glow, reminiscent of incandescent or halogen light sources.

PoE compatible: Integrates with Power over Ethernet lighting systems via standard, low-voltage wires.

Outdoor rating permits use in outdoor covered ceiling applications.

Available with The Naturals, a series of finishes that exude biophilic beauty.

DISTRIBUTIONS

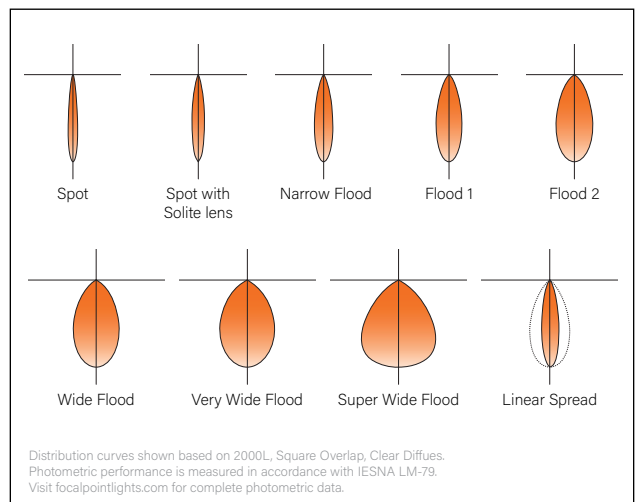

fixture:

project:

HOUSING DETAILS

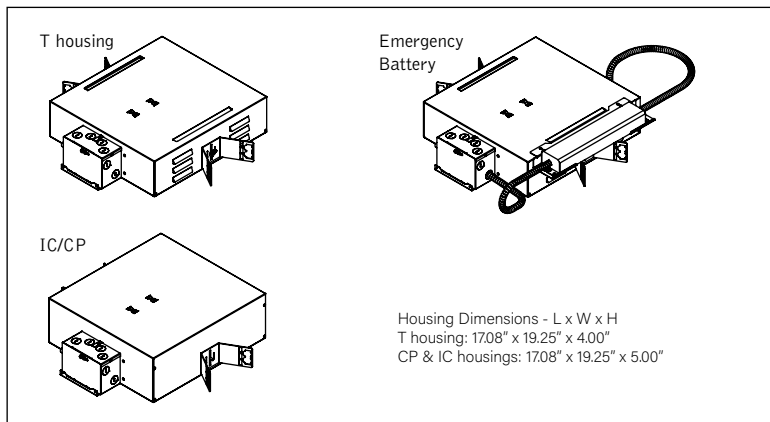

HOUSING SPECIFICATIONS

LED System

Proprietary LED module with single light emitting source. May be specified in 2700K, 3000K, 3500K or 4000K in CRI>80, CRI>90, or CRI>97. Color accuracy within 2 SDCM. Warm Dim within 3-5 SDCM. Aluminum heat sink provides appropriate thermal management.

Construction

T housing for new construction applications. Insulation to be kept 3" away from housing. Type IC inherently protected, suitable for direct contact with insulation. Butterfly brackets allow mounting to 1/2" emt. Order bar hangers as an accessory. Cast aluminum heat sink designed for maximum thermal dissipation. Die-formed housing and integral junction box with (7) 1/2" pry outs. UL & cUL listed for (8) #12 AWG (4 in, 4 out) 90°C conductors and feed through-branch wiring. Accommodates ceiling thicknesses from 0.5"-1.85" standard. For thicker ceiling consult factory. Fixture will not exceed 15lb.

Adjustment

Manual locking 40° vertical tilt and 364° rotation of light module.

Electrical

Choice of constant current dimming drivers. Power factor > .9 typical. PoE compatible: Integrates with Power over Ethernet lighting systems via standard, low-voltage wires.

Emergency Battery

Emergency output—7W for 90 minutes. Maximum mounting height: 19ft. For applications requiring higher than 2000L consult factory for maximum mounting height. Above ceiling access only.

Labels

UL and cUL listed. Suitable for Dry, Damp or Wet Locations indoor use only. Wet Location Solite lens options only. Specify Outdoor rated (OD) for outdoor recessed ceiling applications.

Lumen Maintenance

Reported: L70 at >55,000 hours Calculated: L70 at 204,000 hours
 Reported: L90 at >55,000 hours Calculated: L90 at 59,000 hours
 Derived from EPA TM-21 calculator. Based on typical conditions, consult factory for additional data.

Reliability

At Focal Point, our products are designed to stand the test of time. Each luminaire is engineered using superior components, manufactured with the utmost care and rigorously tested. Contact us for reliability data.

Warranty

LED System rated for operation in ambient environments up to 40°C. 5-year limited warranty.

TRIM SPECIFICATIONS

Aesthetics

Parabolic reflector cone ensures glare free optics. Reflector is die-cast aluminum. Torsion springs pull trim tight to the ceiling with no visible fasteners within the trim. Trims are self-flanged. Non-painted trim matches reflector finish. White or Black painted flange may also be specified. Spot distribution is offered with Solite lens and No lens options. No lens options with greater than 15° vertical tilt, feature a shroud to conceal internal components and maintain a premium aesthetic while providing a narrow spot distribution. The Naturals: 100% low VOC vinyl.

Optics

75-degree cut-off to light source and its image.

Lumen range	Distribution Beam Spread								
	SP	SP with Solite	NFL	FL1	FL2	WFL	VWFL	SWFL	LS
1000 - 2000	12.4°	17.8°	24.6°	31.8°	45.7°	59.5°	71.7°	86.4°	18.5° x 51.2°
	0.22	0.28	0.40	0.52	0.74	0.88	1.00	1.26	0.34 x 0.80
2500 - 4000	-	-	21.2°	34.8°	43.0°	62.0°	72.5°	89.4°	25.3° x 54.5°
	-	-	0.40	0.58	0.70	0.90	1.02	1.24	0.46 x 0.84

PERFORMANCE CHART

See Page 3

Focal Point LLC reserves the right to change specifications for product improvement without notification.

HOUSING ORDERING

Housing Series
 ID+ 4.5" Square Housing FLCS44

Trim Type
 Square Overlap SO
 Square Trimless ST

Lumen Output
 1000 Lumens 1000L
 1500 Lumens 1500L
 2000 Lumens 2000L
 2500 Lumens 2500L
 3000 Lumens 3000L
 3500 Lumens 3500L
 4000 Lumens 4000L
 (Not available with 97+ CRI)

Color Temperature
 (Add 9 for 90 CRI or H for 97 CRI. Leave blank for 80 CRI.
 CRI 97: T & TW housing 3500L max, IC housing 2000L.)
 2700K, 80/90/97+ CRI _27K
 3000K, 80/90/97+ CRI _30K
 3500K, 80/90/97+ CRI _35K
 4000K, 80/90/97+ CRI _40K
 Warm Dim: 2700-1800K, 90+ CRI 92718W
 Warm Dim: 3000-1800K, 90+ CRI 93018W
 *(1000L, 1500L, 2500L only.
 IC, UNV or LV available with 1000L & 1500L only.)

Distribution
 Spot (2000L max.) SP
 Narrow Flood NFL
 Flood 1 FL1
 Flood 2 FL2
 Wide Flood WFL
 Very Wide Flood VWFL
 Super Wide Flood SWFL
 Linear Spread Lens LS

Voltage
 UNV 120/277 Volt UNV
 (L11 & LD1 2500L max., LZ1, DZ1, D11 & LFP 2000L max.,
 LH1 1500L max.)
 120 Volt 120
 277 Volt 277
 Low Voltage LV
 (2500L max.)

Driver
 0-10V - 0% Dimming LZ1
 0-10V - 1% Dimming L11
 0-10V - 10% Dimming LD1
 Forward Phase (120V only) LFP
 Low Voltage, PoE Compatible LVN
 (No driver, LV Voltage only. Not available with EM.)
 Lutron Hi-Lume EcoSystem (LDE1) - 1% Dimming LH1
 DALI - 0% Dimming DZ1
 DALI - 1% Dimming D11

Housing Type
 IC rated IC
 (L11, LD1 & LVN 2500L max. LZ1, DZ1, D11 & LFP 2000L max.
 LH1 1500L max.)
 Non-IC T
 (LZ1, LH1, DZ1, D11 3000L max. LFP 3500L max.)
 Non-IC Wood TW
 (ST only, requires Trimless Wood Kit.)

Factory Options
 Bar Hangers BH
 Chicago Plenum CP
 Emergency Battery with Remote Test Switch EMR
 (T housing only. Not available with Warm Dim.
 Above ceiling access only.)
 Outdoor Rated OD
 (LD1 driver only, IC housing 2500L max. Solite lens optic only.
 See dimming Performance Chart on page 3.)

TRIM ORDERING

Aperture
 4.5" Square Aperture LCS44

Trim Type
 Square Die-Cast Overlap SDO
 Square Die-Cast Trimless SDT

Optic
 (SP distribution available with all Optic options,
 all other distributions SL only)
 Solite Lens SL
 Spot Optic, no lens, for 0°-15° tilt SP00
 Spot Optic, no lens, for 15°-30° tilt SP30
 Spot Optic, no lens, for 25°-40° tilt SP40

Color
 (See finishes page for The Naturals options)
 Clear Diffuse CD
 Warm Diffuse WD
 Black BK
 White WH

Optional Flange Finish
 (Overlap CD & WD finish only.) (For matching finishes leave blank)
 Black Painted BP
 White Painted WP

ACCESSORIES

Distribution Kit FLCS44-
 (Order kits to change distribution in field.
 Add Distribution code from above. Example FLCS44-SP)
Spot Optic Title Kit KIT-
 (Add code for desired title degree -
 15°-30° = SP30, 25°-40° = SP40, Both = SPB)
Trimless Wood Kit FLCS44-
 (One kit suggested per 10 units) WOOD-KIT

FLCS44



LCS44

FLCS44-

FLCS44-

FLCS44-

4.5" SQUARE ADJUSTABLE DOWNLIGHT PERFORMANCE TABLE

Lumen Output	Delivered Lumens	System Watts	LPW
1000L	1073	11.5	93
 1000L	871	14.6	60
1500L	1553	16.8	93
 1500L	1571	23.5	67
2000L	2086	23.7	88
2500L	2415	27.2	89
 2500L	2381	37.2	64
3000L	2897	32.5	89
3500L	3337	38.1	88
4000L	3878	44.2	88

Based on SL optic, 3500K, 80CRI, Narrow Flood, Clear Diffuse. Warm Dim based on 3000 - 1800K, 90 CRI. Overlap and trimless offer identical performance. Delivered lumen output may vary +/- 5%. Actual wattage may vary +/- 5%.

4.5" SQUARE ADJUSTABLE DOWNLIGHT CBCP CHART

Lumen Output	Distribution	Beamspread	Center Beam Candlepower (CBCP)
2000L	SP	12.4°	30912
	SP with Solite lens	17.8°	16934
	NFL	24.6°	8802
	FL1	31.8°	5039
	FL2	45.7°	2823
	WFL	59.5°	1805
	VWFL	71.7°	1386
	SWFL	86.4°	1018
	LS	18.5° x 51.2°	5499

OUTDOOR RATED (OD) DRIVER DIMMING PERFORMANCE TABLE

Lumen Output	Minimum Dimming Level
1000L	13%
1500L	10%
2000L	10%
2500L	10%
3000L	10%
3500L	10%
4000L	10%

4.5" SQUARE DOWNLIGHT LUMEN MULTIPLIER TABLE

Color Temperature & CRI¹

Color Options	Lumen Output	Color Temperature & CRI	Multiplier
Standard White	All Outputs	2700K, 80+ CRI [27K]	0.92
		2700K, 90+ CRI [927K]	0.79
		2700K, 97+ CRI [9727K]	0.67
		3000K, 80+ CRI [30K]	0.98
		3000K, 90+ CRI [930K]	0.83
		3000K, 97+ CRI [9730K]	0.72
		3500K, 80+ CRI [35K]	1.00
		3500K, 90+ CRI [935K]	0.82
		3500K, 97+ CRI [9735K]	0.73
		4000K, 80+ CRI [40K]	1.01
4000K, 90+ CRI [940K]	0.84		
4000K, 97+ CRI [9740K]	0.76		
 Warm Dim	1000L	2700-1800K, 90+ CRI [92718W]	0.77
		3000-1800K, 90+ CRI [93018W]	0.87
	1500L	2700-1800K, 90+ CRI [92718W]	0.82
		3000-1800K, 90+ CRI [93018W]	1.05
	2500L	2700-1800K, 90+ CRI [92718W]	0.78
		3000-1800K, 90+ CRI [93018W]	0.95

Color³

Trim	Color	Multiplier
All	Clear Diffuse [CD]	1.00
	Warm Diffuse [WD]	0.98
	White [WH]	1.02
	Black [BK]	0.95
	Woven Linen [WLN]	0.93
	Walnut [WLT]	0.45
	Gray Elm [GRE]	0.72
	Chestnut [CHT]	0.75
	Light Oak [LOK]	0.90

Distribution²

Trim	Distribution	Square Overlap Multiplier		Square Trimless Multiplier	
		1000L - 2000L	2500L - 4000L	1000L - 2000L	2500L - 4000L
Square Overlap	Spot [SP]	1.11	—	1.11	—
	Spot with Solite lens [SP]	1.09	—	1.09	—
	Narrow Flood [NFL]	1.04	0.97	1.04	0.97
	Flood 1 [FL1]	1.01	0.93	1.01	0.93
	Flood 2 [FL2]	1.03	0.98	1.03	0.98
	Wide Flood [WFL]	0.98	0.91	0.98	0.91
	Very Wide Flood [VWFL]	0.98	0.88	0.98	0.88
	Super Wide Flood [SWFL]	0.94	0.85	0.94	0.85
	Linear Spread [LS]	1.00	0.93	1.00	0.93

How To Use Lumen Multipliers

Formula:

(Lumen Output Value) x (Color Temperature & CRI¹) x (Distribution²) x (Color³)

Example:

FLCS44-SO-2000L-935K-FL1-SDO-WH
 (2000) x (0.82) x (1.01) x (1.02) ≈ 1690lm (estimated delivered lumens)

Multiplier charts are provided to aid with estimation of lumen levels across options. Apply multipliers against ordered Lumen Output to estimate Delivered Lumens. An estimation should make use of all tables through consecutive application of three multipliers. Refer to IES files for most accurate photometric information.

Finishes



STANDARD FINISHES



WHITE WH BLACK BK CLEAR DIFFUSE CD WARM DIFFUSE WD

THE NATURALS (25% SCALE)



LIGHT OAK LOK GRAY ELM GRE CHESTNUT CHT WALNUT WLT WOVEN LINEN WLN