

ID+ 3.5" Pure Cylinder

LED SURFACE MOUNT

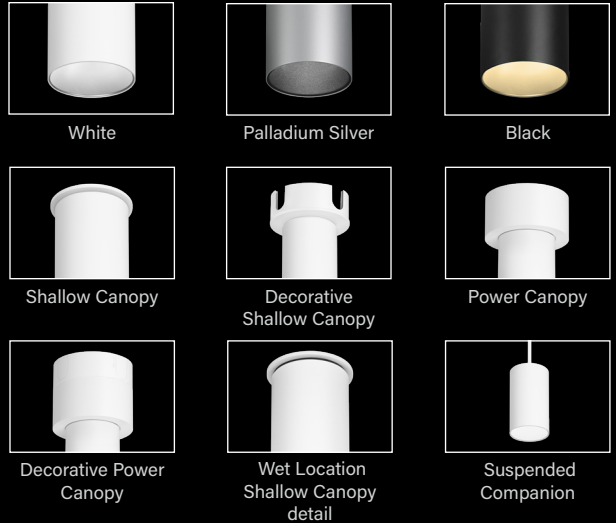

The Naturals collection - Chestnut shown



White

Palladium Silver

Black

Shallow Canopy

Decorative Shallow Canopy

Power Canopy

Decorative Power Canopy

Wet Location Shallow Canopy detail

Suspended Companion

DIMENSIONAL DATA

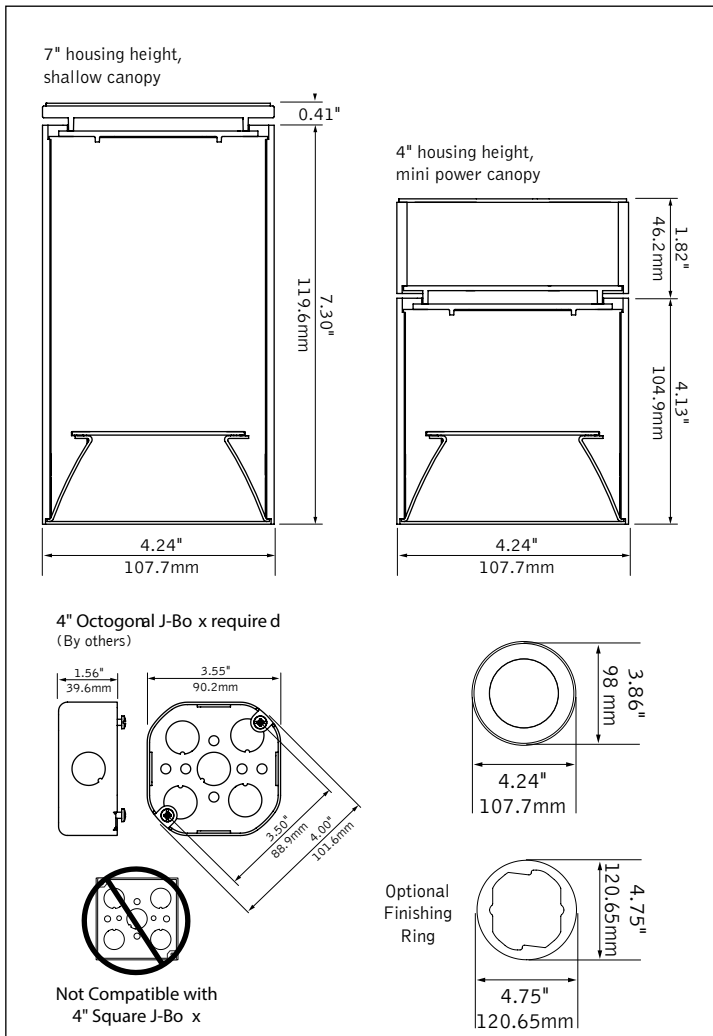

FEATURES

3.5" solid body surface mount cylinder available in 4" or 7" housing heights.

50°, 60° and 75° cut-off reflector options available.

25° to 90° beam spreads support accent lighting, task lighting and general illumination.

Multiple canopy options enable various driver offerings and conduit installations while maintaining premier aesthetics.

Available with The Naturals, a series of finishes that exude biophilic beauty.

PoE compatible: Integrates with Power over Ethernet lighting systems via standard, low-voltage wires.

Cohesive and powerful performance by using the optics and light sources of ID+ 3.5" recessed family.

DISTRIBUTIONS

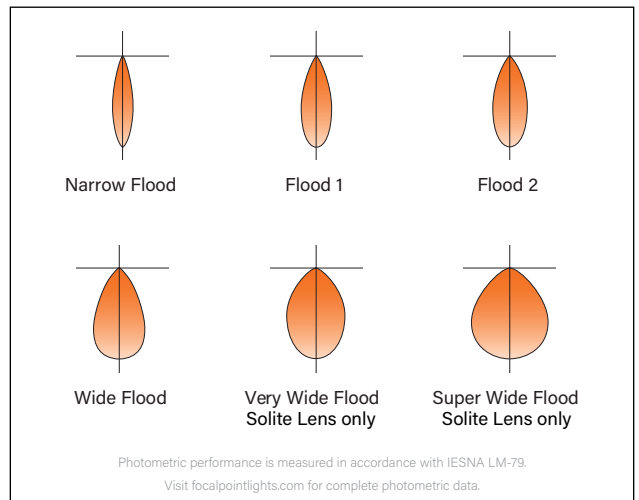

fixture:

project:

SPECIFICATIONS

LED System

Proprietary LED module with single light emitting source. May be specified in 2700K, 3000K, 3500K or 4000K in CRI>80 or CRI>90. 3500K and 4000K with CRI>90 have a cyanosis observation index (COI) of 3.3 or less. Color accuracy within 2 SDCM. Aluminum heat sink provides appropriate thermal management.

Construction

Housing is extruded aluminum. Internal reflector (DNT and DNS) are spun aluminum. DSS reflector is die-cast aluminum. Gasket supports Wet Location rating. Fixture will not exceed 7 lb.

Optics

Optic	Cut-off degree	Distribution Beam Spread Spacing Criteria					
		NFL	FL1	FL2	WFL	VWFL	SWFL
DNT	50°	26° 0.54	37° 0.62	45° 0.76	58° 0.87	—	—
DNS	60°	25° 0.42	37° 0.63	45° 0.75	56° 0.92	—	—
DSS	75°	26° 0.44	37° 0.60	45° 0.72	56° 0.84	74° 1.07	91° 1.24

Electrical

Choice of constant current dimming drivers. Power factor > .9 typical. PoE compatible: Integrates with Power over Ethernet lighting systems via standard, low-voltage wires. L11 & LFP with Shallow Canopy (SC), Decorative Shallow Canopy (DSC), and Mini Power Canopy (MPC) not Right Light as standard, consult factory. Shallow Canopy with integral driver.

Emergency

Emergency output —7W for 90 minutes. Maximum mounting height: 17ft for CD/ WH reflectors, and 15.1ft for WD/ BK reflectors. J-box cannot be recessed above the ceiling with Emergency Battery.

Labels

UL and cUL listed. Suitable for Dry or Damp Locations, indoor use as standard. Specify Wet Location with Shallow Canopy (SC), Power Canopy (PC) or Mini Power Canopy (MPC) for indoor or outdoor covered ceiling applications.

Finish

Polyester powder coat applied over a multi-stage pre-treatment. The Naturals: 100% low VOC vinyl.

Lumen Maintenance

Calculated: L70 at 200,000 hours Reported: L70 at >55,000 hours
(Derived from EPA TM-21 calculator per 10,000 hours of LED test data)

Reliability

At Focal Point, our products are designed to stand the test of time. Each luminaire is engineered using superior components, manufactured with the utmost care and rigorously tested. Contact us for reliability data.

Warranty

5 year limited warranty. Refer to the following table for temperature ranges.

Ambient Temperature	Maximum Available Lumen Level	Application
-30°C to 45°C	700DN	Indoor & Outdoor Covered Ceilings
-30°C to 40°C	900DN	Indoor & Outdoor Covered Ceilings
-30°C to 35°C	1100DN	Indoor & Outdoor Covered Ceilings
-30°C to 35°C	1300DN	Indoor & Outdoor Covered Ceilings
-30°C to 30°C	1500DN	Indoor & Outdoor Covered Ceilings
-30°C to 25°C	1700DN	Indoor only
-30°C to 25°C	1900DN (PC, MPC, or DPC only)	Indoor only
-30°C to 25°C	2100DN (PC or DPC only)	Indoor only
-30°C to 25°C	2300DN (PC or DPC only)	Indoor only

7" ORDERING

Luminaire Series

ID+ 3.5" Pure Cylinder

Trim Type

Round

Housing Height

7"

Direct Lumen Output

(Refer to temperature ranges under Warranty).

700 Lumens*

900 Lumens*

1100 Lumens

1300 Lumens

1500 Lumens

1700 Lumens

1900 Lumens (PC, DPC, MPC only)

2100 Lumens (PC or DPC only)

2300 Lumens (PC or DPC only, DSS not available.)

Color Temperature

(Add 9 for 90 CRI or H for 97 CRI. Leave blank for 80 CRI.)

2700K, 80/90/97+ CRI

3000K, 80/90/97+ CRI

3500K, 80/90/97+ CRI

4000K, 80/90/97+ CRI

Warm Dim | 2700-1800K, 90+ CRI**

3000-1800K, 90+ CRI**

Tunable | 1800-4000K, 90+ CRI (900DN max)†

2700-5000K, 90+ CRI (1300DN max)†

2700-6500K, 90+ CRI (1300DN max)†

Circuits

Single Circuit

Voltage

UNV 120/277 Volt

120 Volt

277 Volt

Low Voltage (LVN control system only)

Canopy Configuration

Shallow Canopy, Integral Driver¹

Shallow Canopy with decorative J-box cover,¹

Integral Driver

Power Canopy, driver inside canopy²

Power Canopy with decorative J-box cover,²

driver inside canopy

Mini Power Canopy, drive inside canopy

(1900DN max. L11 & LFP only. Not available with

Warm Dim & Tunable White)

Canopy Color³

(See finishes page for The Naturals options available with SC, PC and MPC canopies only)

Matte Black

Matte White

Paladium Silver

Control System & Dimming Level

0-10V - 0% Dimming⁴

0-10V - 1% Dimming

0-10V - 10% Dimming⁴

Low Voltage, PoE compatible LVN

(SC, DSC only, LV Voltage only,

EMR, Warm Dim & Tunable White not available.)

Phase Dimming

(120V only, 700DN & 900DN not available with PC or DPC)

Lutron Hi-Lume EcoSystem (LDE1) -⁴

1% Dimming (700DN, 900DN not available)

DALI - 0% Dimming⁴

DALI - <1% Dimming (Tunable White)⁴

DALI - 1% Dimming⁴

Mounting

Surface Mount

Direct Optic

50° cut-off cone

60° cut-off cone

75° cut-off cone with Solite Lens

Direct Distribution

Narrow Flood

Flood 1

Flood 2

Wide Flood

Very Wide Flood (DSS only)

Super Wide Flood (DSS only)

Factory Options

Wet Location

(Refer to temperature ranges under Warranty).

(Not available with DSC or DPC)

Emergency Battery Remote

(J-box cannot be recessed above the ceiling. Remote test switch,

LV, Warm Dim & Tunable White not available.)

Reflector Color

Clear Diffuse

Warm Diffuse

White

Black

Luminaire Finish³

(See finishes page for The Naturals options)

Black

White

Paladium Silver

Custom Color option available

*LFP not available with PC or DPC.)

** (1500DN only, DNT or DNS only, PC or DPC only.)

† (DZTW with PC or DPC only.)

‡ (1700DN max., L11, LFP & LVN only)

§ (2300DN not available with DSS.)

¶ (Specify your RAL color value.)

||| Extended lead time consult factory)

^ (PC or DPC only)



Options in orange qualify for the Quickship program. 10-day up to 100 pieces. Refer to Quickship Guide for complete details.

fixture:

project:

SPECIFICATIONS



LED System

Proprietary LED module with single light emitting source. May be specified in 2700K, 3000K, 3500K or 4000K in CRI>80 or CRI>90. 3500K and 4000K with CRI>90 have a cyanosis observation index (COI) of 3.3 or less. Color accuracy within 2 SDCM. Aluminum heat sink provides appropriate thermal management.

Construction

Housing is extruded aluminum. Internal reflector (DNS) is spun aluminum. DSS reflector is die-cast aluminum. Gasket supports Wet Location rating. Fixture will not exceed 7 lb.

Optics

Optic	Cut-off degree	Distribution Beam Spread Spacing Criteria					
		NFL	FL1	FL2	WFL	VWFL	SWFL
DNS	 60°	25° 0.42	37° 0.63	45° 0.75	56° 0.92	—	—
DSS	 75°	26° 0.44	37° 0.60	45° 0.72	56° 0.84	74° 1.07	91° 1.24

Electrical

Choice of constant current dimming drivers. Power factor > .9 typical. PoE compatible: Integrates with Power over Ethernet lighting systems via standard, low-voltage wires. L11 & LFP with Mini Power Canopy (MPC) not Right Light as standard, consult factory. Shallow Canopy with integral driver.

Emergency

Emergency output —7W for 90 minutes. Maximum mounting height: 17ft for CD/ WH reflectors, and 15.1ft for WD/ BK reflectors. J-box cannot be recessed above the ceiling with Emergency Battery.

Labels

UL and cUL listed. Suitable for Dry or Damp Locations, indoor use as standard. Specify Wet Location with Power Canopy (PC) or Mini Power Canopy (MPC) for indoor or outdoor covered ceiling applications.

Finish

Polyester powder coat applied over a multi-stage pre-treatment. The Naturals: 100% low VOC vinyl.

Lumen Maintenance

Calculated: L70 at 200,000 hours Reported: L70 at >55,000 hours
(Derived from EPA TM-21 calculator per 10,000 hours of LED test data)

Reliability

At Focal Point, our products are designed to stand the test of time. Each luminaire is engineered using superior components, manufactured with the utmost care and rigorously tested. Contact us for reliability data.

Warranty

5 year limited warranty. Refer to the following table for temperature ranges.

Ambient Temperature	Maximum Available Lumen Level	Application
-30°C to 45°C	700DN	Indoor & Outdoor Covered Ceilings
-30°C to 40°C	900DN	Indoor & Outdoor Covered Ceilings
-30°C to 35°C	1100DN	Indoor & Outdoor Covered Ceilings
-30°C to 35°C	1300DN	Indoor & Outdoor Covered Ceilings
-30°C to 30°C	1500DN	Indoor & Outdoor Covered Ceilings
-30°C to 25°C	1700DN	Indoor only
-30°C to 25°C	1900DN	Indoor only
-30°C to 25°C	2100DN (PC or DPC only)	Indoor only
-30°C to 25°C	2300DN (PC or DPC only)	Indoor only

4" ORDERING

Luminaire Series

ID+ 3.5" Pure Cylinder

FLCY3N

Trim Type

Round

RD

Housing Height

4"

FLCY3N

RD

4H

(Up to 24" in 1/2" increment with conditions. Consult factory for details.)

Direct Lumen Output

(Refer to temperature ranges under Warranty).

700 Lumens*

900 Lumens*

1100 Lumens

1300 Lumens

1500 Lumens

1700 Lumens

1900 Lumens

2100 Lumens (PC or DPC only)

2300 Lumens (PC or DPC only, DSS not available)

Color Temperature

(Add 9 for 90 CRI or H for 97 CRI. Leave blank for 80 CRI.)

2700K, 80/90/97+ CRI

3000K, 80/90/97+ CRI

3500K, 80/90/97+ CRI

4000K, 80/90/97+ CRI

Warm Dim 2700-1800K, 90+ CR**

3000-1800K, 90+ CRI**

Tunable 1800-4000K, 90+ CRI (900DN max)†

White 2700-5000K, 90+ CRI (1300DN max)†

2700-6500K, 90+ CRI (1300DN max)†

Circuits

Single Circuit

Voltage

UNV 120/277 Volt

120 Volt

277 Volt

Canopy Configuration

Power Canopy, driver inside canopy¹

Power Canopy with decorative J-box cover,¹

driver inside canopy

Mini Power Canopy, driver inside canopy

(1900DN max. L11 & LFP only. Not available with Warm Dim & Tunable White)

Canopy Color²

(See finishes page for The Naturals options available with PC and MPC canopies only)

Matte Black

Matte White

Paladium Silver

Control System & Dimming Level

0-10V - 0% Dimming³

0-10V - 1% Dimming

0-10V - 10% Dimming³

Phase Dimming

(120V only. 700L & 900L not available with PC or DPC)

Lutron Hi-Lume EcoSystem (LDE1) -³

1% Dimming (700DN & 900DN not available.)

DALI - 0% Dimming³

DALI - <1% Dimming (Tunable White)³

DALI - 1% Dimming³

Mounting

Surface Mount

Direct Optic

60° cut-off cone

75° cut-off cone with Solite Lens

Direct Distribution

Narrow Flood

Flood 1

Flood 2

Wide Flood

Very Wide Flood (DSS only)

Super Wide Flood (DSS only)

Factory Options

Wet Location

(Refer to temperature ranges under Warranty).

(Not available with DPC)

Emergency Battery Remote

(J-box cannot be recessed above the ceiling. Remote test switch. Not available with Warm dim & Tunable white.)

Reflector Color

Clear Diffuse

Warm Diffuse

White

Black

Luminaire Finish²

(See finishes page for The Naturals options)

Black

White

Paladium Silver

Custom Color option available

(LFP not available with PC or DPC.)

** (1500DN only, DNS only, PC or DPC only)

† (DZTW with PC or DPC only)

‡ (2300DN not available with DSS)

§ (Specify your RAL color value. Extended lead time consult factory)

¶ (PC or DPC only)

PERFORMANCE CHARTS

STANDARD WHITE				
CCT	Lumen Output	Delivered Lumens	Tested System Watts	LPW
3500K, 80 CRI	700DN	663	8	79
	900DN	852	10	90
	1100DN	1041	12	88
	1300DN	1231	15	81
	1500DN	1420	17	82
	1700DN	1609	20	82
	1900DN	1799	22	82
	2100DN	1988	24	82
	2300DN	2177	27	82

Based on Short Cone (DNS), 3500K, 80CRI, Wide Flood, Clear Diffuse. See page 5 for lumen performance multipliers. Lumen output may vary +/- 5%. Actual wattage may vary +/- 5%.

WD WARM DIM				
CCT	Lumen Output	Delivered Lumens	System Watts	LPW
93018K	1500DN	1442	25	57
92718K	1500DN	1423	25	56

TW TUNABLE WHITE				
CCT	Lumen Output	Delivered Lumens	System Watts	LPW
2700K (2700-5000K & 2700-6500K)	700DN	643	13	48
	900DN	837	17	50
	1100DN	1031	21	50
	1300DN	1212	24	50
1800K (1800-4000K)	700DN	650	20	33
	900DN	833	25	34

LUMEN MULTIPLIER TABLE

Optic & Distribution

Trim Type	Optic	Distribution	Multiplier
Round [RD]	Tall Cone with 50° cut-off [DNT]	Narrow Flood [NFL]	1.12
		Flood 1 [FL1]	0.92
		Flood 2 [FL2]	1.06
		Wide Flood [WFL]	0.92
	Short Cone with 60° cut-off [DNS]	Narrow Flood [NFL]	0.99
		Flood 1 [FL1]	0.96
		Flood 1 [FL1]	0.92
		Wide Flood [WFL]	0.95
	Super Short Cone with Solite Lens with 75° cut-off [DSS]	Narrow Flood [NFL]	0.95
		Flood 1 [FL1]	0.89
		Flood 2 [FL2]	0.94
		Wide Flood [WFL]	0.93
		Very Wide Flood [VWFL]	1.00
	Super Wide Flood [SWFL]	0.95	

Reflector Color

Trim Type	Optic	Distribution	Multiplier
Round [RD]	Tall Cone with 50° cut-off [DNT]	Clear Diffuse [CD]	1.00
		Warm Diffuse [WD]	0.92
		White [WH]	1.09
		Black [BK]	0.46
	Short Cone with 60° cut-off [DNS]	Clear Diffuse [CD]	1.00
		Warm Diffuse [WD]	0.96
		White [WH]	1.12
		Black [BK]	0.62
	Super Short Cone with Solite Lens with 75° cut-off [DSS]	Clear Diffuse [CD]	1.00
		Warm Diffuse [WD]	0.97
		White [WH]	1.16
		Black [BK]	0.86

Color Lumen Multipliers

CRI	STANDARD WHITE CCT				WARM DIM CCT RANGES		TUNABLE WHITE CCT RANGES		
	2700	3000	3500	4000	2700-1800K	3000-1800K	1800-4000K	2700-5000K	2700-6500K
80+	0.92	0.98	1.00	1.01	—	—	—	—	—
90+	0.76	0.79	0.82	0.84	0.95	0.96	1.00	1.00	1.00
97+	0.67	0.72	0.76	0.76	—	—	—	—	—

How To Use Lumen Multipliers

Formula: (Lumen Output Value) x (Color Temperature & CRI) x (Optic & Distribution)

Example: FLCY3N-RD-1000DN-35K-DNT-FL1-CD

(1000) x (1.00) x (0.92) ≈ 920 lm (estimated delivered lumens)

DIMENSIONAL DATA CONTINUED

SC - Shallow Canopy, Integral Driver

■ Indicates Driver Location

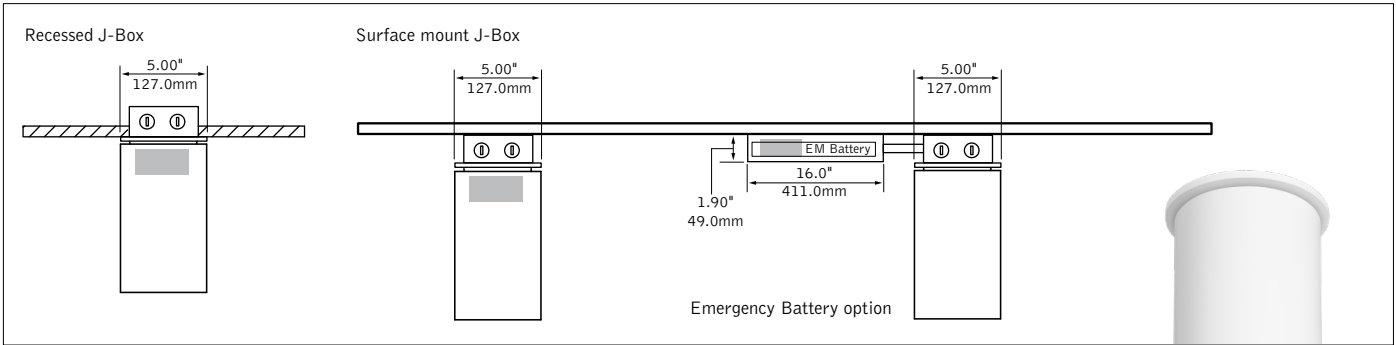

MPC - Mini Power Canopy

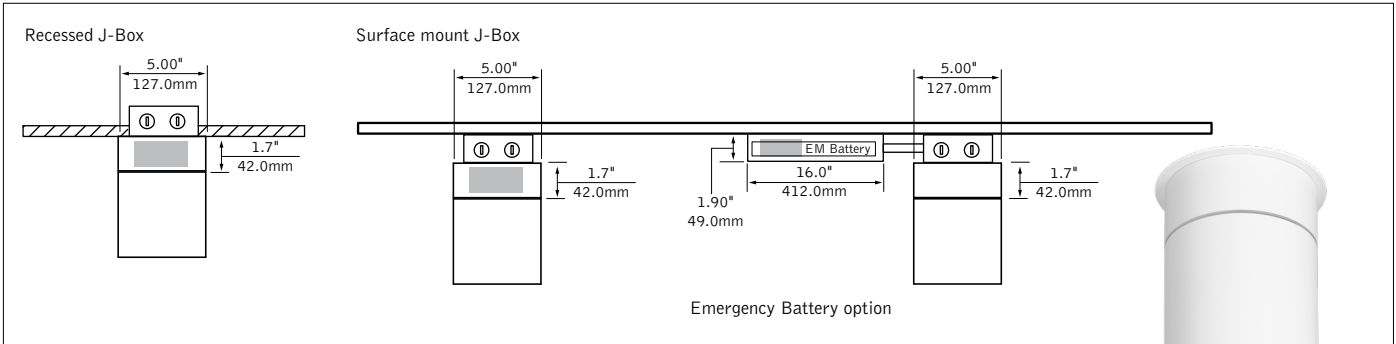

PC - Power Canopy

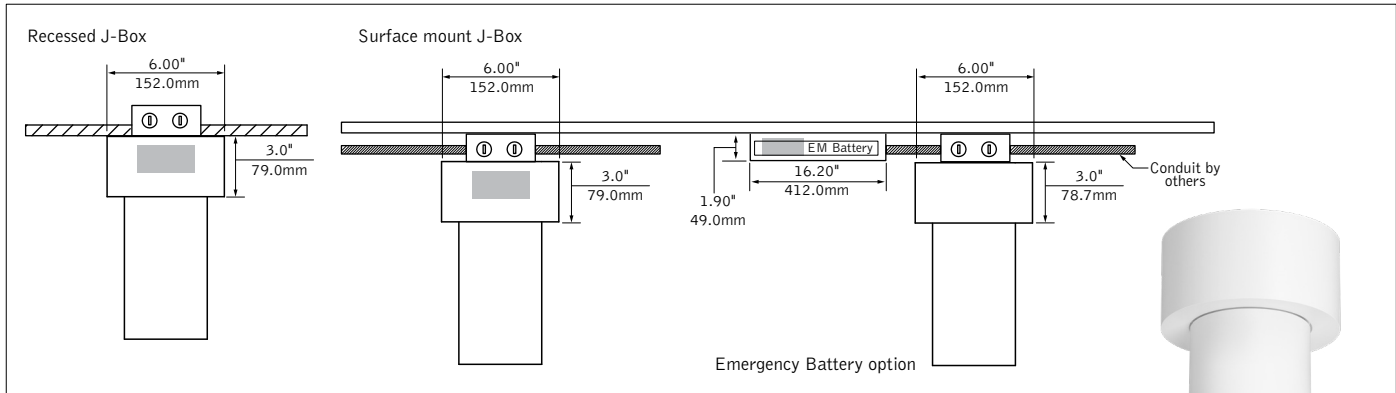

DSC - Shallow Canopy with decorative J-box cover, Integral Driver

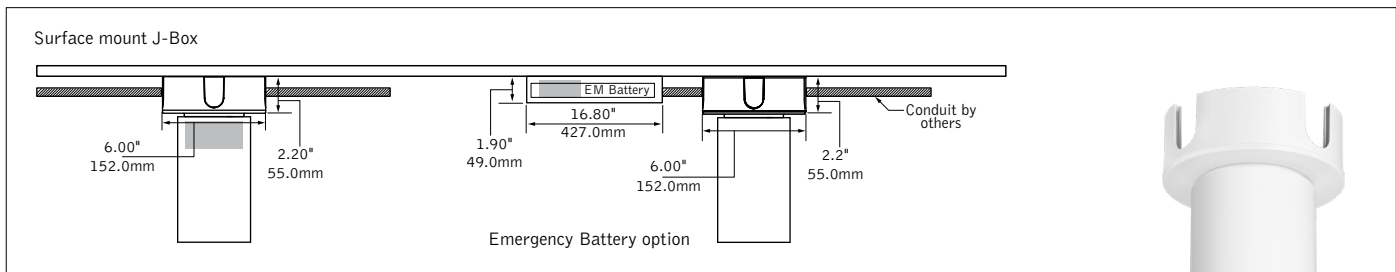

DPC - Power Canopy with decorative J-box cover

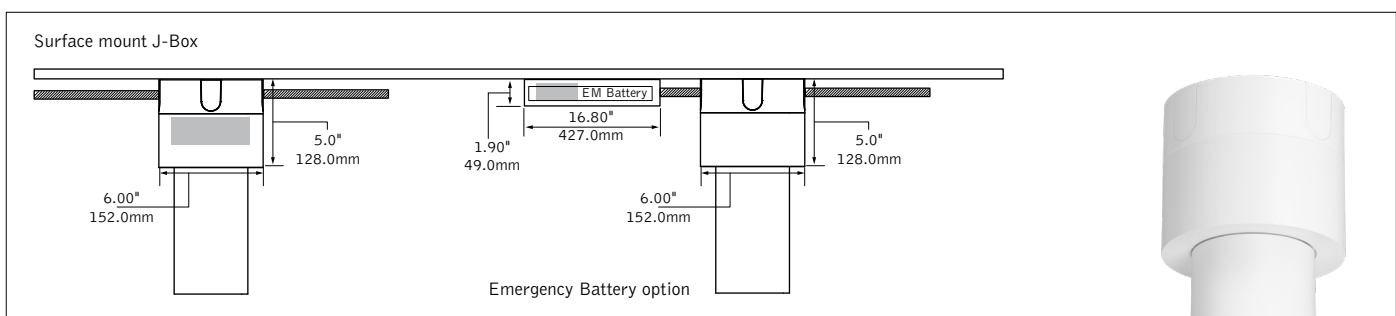

Finishes



STANDARD FINISHES



WHITE

WH



BLACK

BK



PALLADIUM SILVER

PS

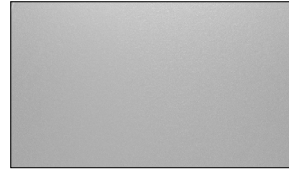

CLEAR DIFFUSE

CD



WARM DIFFUSE

WD

THE NATURALS (25% SCALE)



LIGHT OAK

LOK



GRAY ELM

GRE



CHESTNUT

CHT

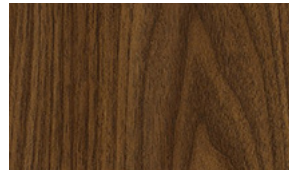

WALNUT

WLT



WOVEN LINEN

WLN