

Seem[®] 2 Drywall/Hard/Specialty Ceiling

LED

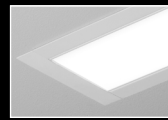

trim flange

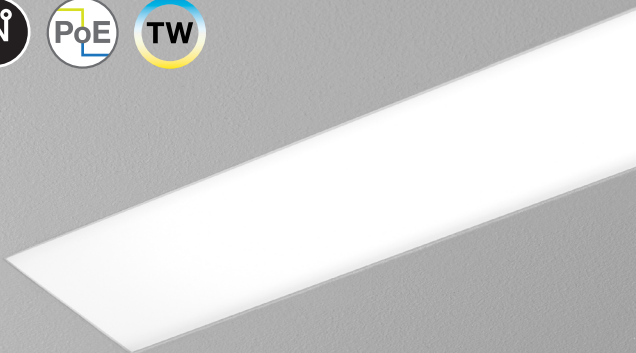

corner detail

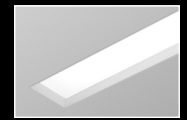

regress lens

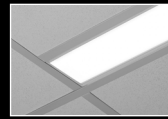

grid ceiling companion



wall to ceiling companion

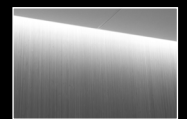

perimeter companion

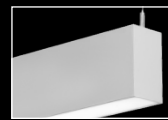

suspended & wall mount companions

DIMENSIONAL DATA

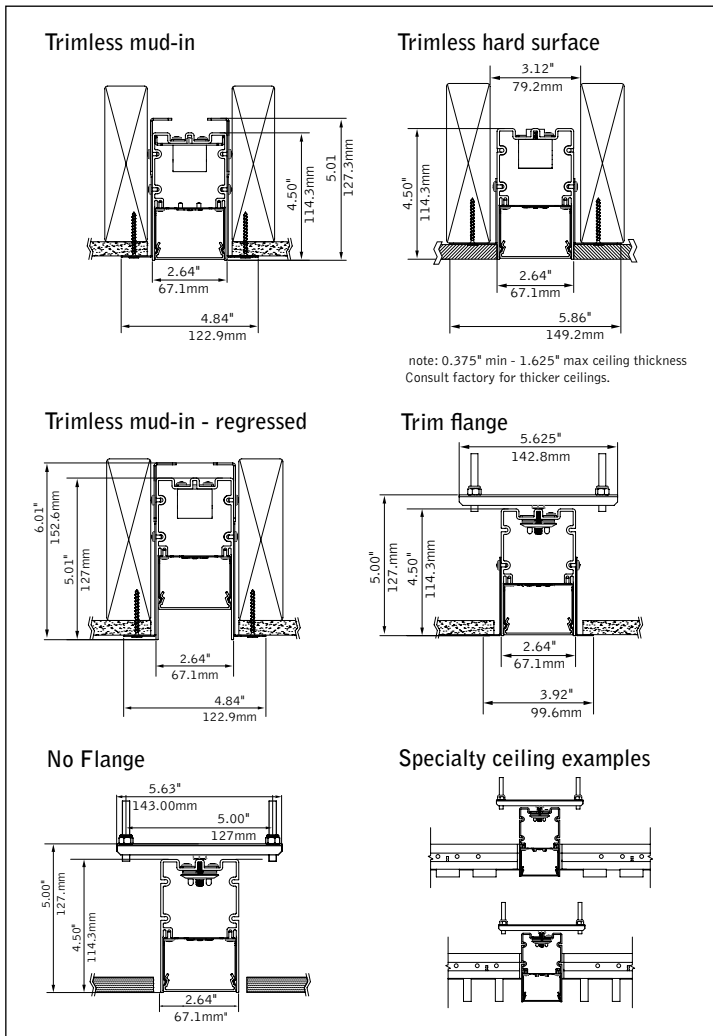

FEATURES

- Narrow extruded aluminum 2.5" aperture recessed slot LED.
- Integrates with ceiling or wall in a variety of mounting styles for a clean, unobtrusive aesthetic.
- Individual units and continuous runs in 1" increments.
- Frosted acrylic lens provides uninterrupted illumination, without pixels or shadows.
- LED position and lens material optimized to provide the perfect blend of high performance and visual comfort.
- Tunable White: Supports human activity, well-being, and preferences with a light quality that evolves throughout the day.
- Connected Solutions: Integrates with wired and wireless building lighting control systems.
- PoE compatible: Integrates with Power over Ethernet lighting systems via standard, low-voltage wires.

DISTRIBUTIONS

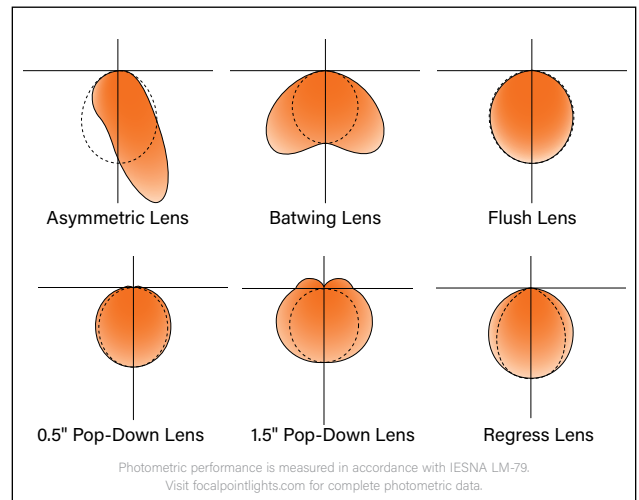

4' PERFORMANCE CHART

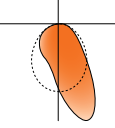
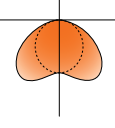
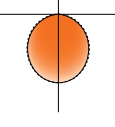
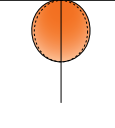
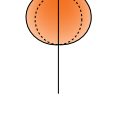
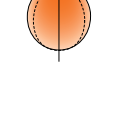
Shielding	Lumens per Foot	Delivered Lumens	Tested System Watts	LPW
Asymmetric Lens 	125LF	500	5.9	85
	250LF	1000	8.2	122
	375LF	1500	11.1	135
	500LF	2000	14.5	138
	625LF	2500	17.9	140
	750LF	3000	22.1	136
	875LF	3500	25.9	135
Batwing Lens 	125LF	500	5.5	91
	250LF	1000	8.7	115
	375LF	1500	12.0	125
	500LF	2000	15.5	129
	625LF	2500	20.0	125
	750LF	3000	24.0	125
	875LF	3500	28.1	125
Flush Lens 	125LF	500	5.6	89
	250LF	1000	9.0	111
	375LF	1500	12.4	121
	500LF	2000	16.2	124
	625LF	2500	20.8	120
	750LF	3000	24.9	120
	875LF	3500	29.3	119
Pop Down 0.5" Lens 	125LF	500	5.9	85
	250LF	1000	9.5	105
	375LF	1500	13.1	114
	500LF	2000	17.2	116
	625LF	2500	22.1	113
	750LF	3000	26.7	112
	875LF	3500	31.3	112
Pop Down 1.5" Lens 	125LF	500	5.8	86
	250LF	1000	9.3	107
	375LF	1500	12.9	116
	500LF	2000	16.9	118
	625LF	2500	21.8	115
	750LF	3000	26.2	114
	875LF	3500	30.8	114
Regress Lens 	125LF	500	5.9	85
	250LF	1000	9.6	104
	375LF	1500	13.4	112
	500LF	2000	17.5	114
	625LF	2500	22.5	111
	750LF	3000	27.1	111
	875LF	3500	31.9	110
1000LF	4000	36.9	109	

Based on 3500K, 4' lengths. Lumen multiplier: Continuous runs = 0.93 Lumen output may vary +/- 5%. Actual wattage may vary +/- 5%.

STANDARD WHITE

Luminaire Series

Seem 2 LED FSM2L

Shielding

Asymmetric Lens AS

Batwing Lens BW

Flush Lens FL

Pop Down 0.5" Lens PD05

Pop Down 1.5" Lens PD15

(2' to 8' Individual Units Only)

Regress Lens SR

Lumen Output

125 Lumens per foot 125LF

(LD1, L11 & D11 driver only. 4' minimum. Not available on patterns.)

250 Lumens per foot 250LF

(3' minimum with LH1. Not available on patterns with LH1)

375 Lumens per foot 375LF

500 Lumens per foot 500LF

625 Lumens per foot 625LF

750 Lumens per foot 750LF

875 Lumens per foot 875LF

1000 Lumens per foot 1000LF

Color Temperature

2700K, 80+ CRI or 90+ CRI 27K or 927K

3000K, 80+ CRI or 90+ CRI 30K or 930K

3500K, 80+ CRI or 90+ CRI 35K or 935K

4000K, 80+ CRI or 90+ CRI 40K or 940K

Circuits & Zones

1 Circuit, non-emergency 1C

Consult Ordering Guide on page 3 for multiple

circuiting and zoning options

Voltage

120/277 UNV Volt UNV

347 Volt (L11 and LD1 driver only) 347V

Low voltage LV

Control System & Dimming Level

0-10V - 10% Dimming LD1

0-10V - 1% Dimming L11

Low Voltage, PoE compatible (No driver. Not available with EM or EC. LV Voltage only) LVN

Lutron Hi-Lume EcoSystem (LDE1) -* LH1

1% Dimming

DALI 1% Dimming* D11

*(Not available with patterns.)

Wattstopper Fixture Sensor** LMFS1

Low Density - 1% Dimming LMFS0

High Density - 1% Dimming

Lutron Athena Wireless Sensor** LAWS

Enlighted Smart Sensor - 1% Dimming** ENL1

WaveLinx Pro - 1% Dimming** WLXP

** (3' minimum length. 7' minimum with ECD/EM. Not available with pop-down lenses. See sensor layout guide)

Ceiling Configuration

No Flange for specialty ceilings (Ex. slat, panel, cloud systems.) NF

Trim Flange Drywall TF

Trim Flange Wood TFW

Mud-in Trimless, 1/2" Drywall XF1

Mud-in Trimless, 5/8" Drywall XF2

Mud-in Trimless, any Drywall Thickness XFF

Non-Drywall Hard Surface XFN

Hard Surface, Wood XFW

Factory Options

(See Ordering Guide for ordering details for DC, EC, EM & ECD.)

Chicago Plenum CP

(Not available with Flex Whip)

Daylight Circuit _DC

Emergency Circuit _EC

Emergency Battery Pack† _EM

Emergency Control Device‡ _ECD

† (4' minimum. 6' minimum with patterns. 120/277 Volt only. Not available at corners.)

6' New York City Flex Whip (120V) FNY1

6' New York City Flex Whip (277V) FNY2

6' Flex Whip FW

Finish

Matte White Housing WH

Luminaire Length

Specify luminaire/row length in 1" increments _ft_in

(2' minimum. Leave blank for patterns.)

Pattern Options

(4' minimum length)

'L' pattern A' x B'

'U' pattern A' x B' x C'

Rectangular pattern A' x B' R

(Consult factory for other pattern options)



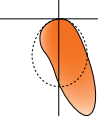
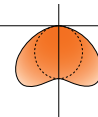
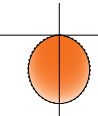
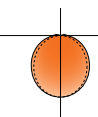
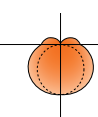
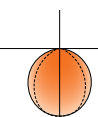

4' PERFORMANCE CHART

Shielding	Lumens per Foot	Delivered Lumens	Tested System Watts	LPW
Asymmetric Lens 	125LF	500	7.25	79.3
	250LF	1000	12.90	93.1
	375LF	1500	18.55	98.5
	500LF	2000	18.3	101.1
	625LF	2500	24.21	102.5
	750LF	3000	29.86	106.8
	875LF	3500	34.34	107.5
	1000LF	4000	45.08	107.8
Batwing Lens 	125LF	500	7.25	76.0
	250LF	1000	12.90	89.2
	375LF	1500	18.55	94.4
	500LF	2000	18.3	96.9
	625LF	2500	24.21	98.3
	750LF	3000	29.86	102.4
	875LF	3500	34.34	103.0
	1000LF	4000	39.71	103.3
Flush Lens 	125LF	500	7.25	69.0
	250LF	1000	12.90	80.9
	375LF	1500	18.55	85.7
	500LF	2000	18.3	87.9
	625LF	2500	24.21	89.2
	750LF	3000	29.86	92.9
	875LF	3500	34.34	93.5
	1000LF	4000	39.71	93.7
Pop Down 0.5" Lens 	125LF	500	7.25	66.2
	250LF	1000	12.90	77.7
	375LF	1500	18.55	82.2
	500LF	2000	18.3	84.4
	625LF	2500	24.21	85.6
	750LF	3000	29.86	89.2
	875LF	3500	34.34	89.7
	1000LF	4000	39.71	90
Pop Down 1.5" Lens 	125LF	500	7.25	65.5
	250LF	1000	12.90	76.9
	375LF	1500	18.55	81.4
	500LF	2000	18.3	83.5
	625LF	2500	24.21	84.7
	750LF	3000	29.86	88.3
	875LF	3500	34.34	88.8
	1000LF	4000	39.71	89.1
Regress Lens 	125LF	500	7.25	60.4
	250LF	1000	12.90	70.9
	375LF	1500	18.55	75.0
	500LF	2000	18.3	77.0
	625LF	2500	24.21	79.3
	750LF	3000	29.86	81.3
	875LF	3500	34.34	81.8
	1000LF	4000	39.71	82.1

Based on 2700K, 80CRI, 4' lengths. Lumen output may vary +/- 5%. Actual wattage may vary +/- 5%

Lumen Multiplier		Wattage Multipliers	
CRI	Multiplier	CCT	Multiplier
80+	1.00	2700K	1.00
90+	0.89	3000K	0.92
		3500K	0.88
		4000K	0.86
		5000K	0.85
		5700K	0.87



TUNABLE WHITE

Luminaire Series

Seem 2 LED FSM2L

Shielding

- Asymmetric Lens AS
- Batwing Lens BW
- Flush Lens FL
- Pop Down 0.5" Lens PD05
- Pop Down 1.5" Lens PD15
- Regress Lens SR

(Housing height 5.5" Ceiling applications only)

Lumen Output

- 125 Lumens per foot 125LF
- 250 Lumens per foot 250LF
- 375 Lumens per foot 375LF
- 500 Lumens per foot 500LF
- 625 Lumens per foot 625LF
- 750 Lumens per foot 750LF
- 875 Lumens per foot 875LF
- 1000 Lumens per foot 1000LF

Color Temperature

- Tunable White: 2700-6500K, 80+ CRI 2765T
- Tunable White: 2700-6500K, 90+ CRI 92765T

Circuits & Zones

- 1 Circuit, non-emergency 1C
- Consult Ordering Guide on page 3 for multiple circuiting and zoning options _C_Z_DL

Voltage

- 120/277 UNV Volt UNV
- 347 Volt Support 347V
- Low voltage LV

Control System & Dimming Level

- DALI 1% Dimming* D1TW
- (Default driver offers DT6 control. It requires two addresses, one for intensity & one for CCT tuning. Consult factory for DT8. Extended lead time applies.)

Ceiling Configuration

- No Flange for specialty ceilings (Ex. slat, panel, cloud systems.) NF
- Trim Flange Drywall TF
- Trim Flange Wood TFW
- Mud-in Trimless, 1/2" Drywall XF1
- Mud-in Trimless, 5/8" Drywall XF2
- Mud-in Trimless, any Drywall Thickness XFF
- Non-Drywall Hard Surface XFN
- Hard Surface, Wood XFW

Factory Options

(See Ordering Guide for ordering details for DC, EC, EM & ECD.)

Chicago Plenum CP

(Not available with Flex Whip)

- Daylight Circuit _DC
- Emergency Circuit _EC
- Emergency Battery Pack† _EM
- Emergency Control Device† _ECD

†(4' minimum. 6' minimum with patterns. 120/277 Volt only. Not available at corners.)

- 6' New York City Flex Whip (120V) FNY1
- 6' New York City Flex Whip (277V) FNY2
- 6' Flex Whip FW

Finish

- Matte White Housing WH

Luminaire Length

- Specify luminaire/row length in 1" increments _ft_in
- (2" minimum. Leave blank for patterns.)

Pattern Options

(4' minimum length)

- 'L' pattern A' x B'
- 'U' pattern A' x B' x C'
- Rectangular pattern A' x B' R

(Consult factory for other pattern options)

SPECIFICATIONS

LED System

Proprietary linear LED module incorporates premium LEDs on a robust platform to achieve excellent thermal management. LEDs are placed to promote a uniform appearance. Available in 2700K, 3000K, 3500K or 4000K with CRI>80 or CRI>90, 3 SDCM. 3500K and 4000K with CRI>90 have a cyanosis observation index (COI) of 3.3 or less. LED modules and drivers are replaceable from below.

Construction

One piece extruded aluminum housing. 20 Ga. steel end caps. Housing for new construction applications. Flush lens weights: 4' unit 12.2 lbs., 8' unit: 24.4 lbs. Regress lens weights: 4' unit: 13.2 lbs., 8' unit: 26.4 lbs..

Optic

Reflectors fabricated of 22 Ga. steel finished in High Reflectance White powder coat. Extruded acrylic lens .07" thick with satin finish, up to 8' continuous.

Electrical

Luminaires are pre-wired with factory installed branch circuit wiring and over-molded quick connects. Standard 120-277V constant current driver includes 0-10V analog dimming. Power factor > .9. PoE compatible: Integrates with Power over Ethernet lighting systems via standard, low-voltage wires. PoE runs require an independent PoE node and power feed for each luminaire section.

DETAILS

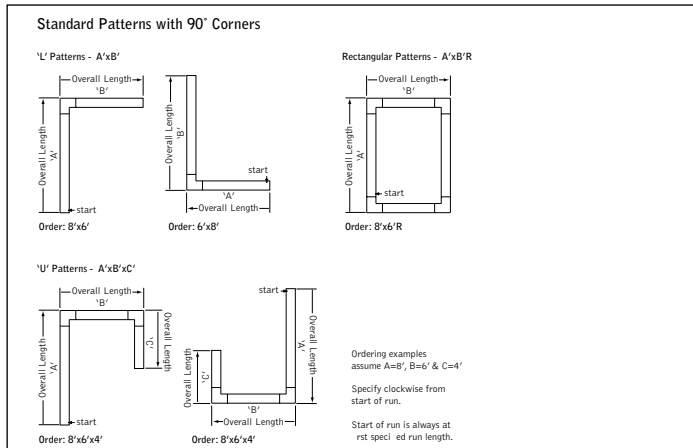

Emergency

Emergency Battery output - 10 watts for 90 minutes. Maximum mounting height: 17.9ft. Emergency Circuit with Connected Solutions (LMFS1, LMFS2, ENL1, WLXP) shipped standard with leads to connect UL924 compliant device, by others.

Labels

UL and cUL listed. Suitable for Dry or Damp Locations, indoor use only.

Finish

Polyester powder coat applied over a multi-stage pre-treatment.

Lumen Maintenance

Reported: L70 at >61,000 hours	Calculated: L70 at 385,000 hours
L90 at >61,000 hours	L90 at 103,000 hours

Derived from EPA TM-21 calculator. Based on typical conditions, consult factory for additional data.

Reliability

At Focal Point, our products are designed to stand the test of time. Each luminaire is engineered using superior components, manufactured with the utmost care and rigorously tested. Contact us for reliability data.

Warranty

LED system rated for operation in ambient environments up to 25°C. 5-year limited warranty.

Focal Point provides flexibility in meeting the needs of each project by integrating with several building lighting control systems. A variety of sensors, drivers and other components can be specified that allow the luminaires to communicate with wired and wireless networks. All zoning can be digitally reconfigured through the application software. Daylight harvesting, occupancy sensing, integration with HVAC systems, and individual controls enable the monitoring and modulating of light levels and temperature in order to save energy, reduce costs and maximize occupants' comfort. All Connected Solutions luminaires require a compatible building control system.†

Connected Solution	Ordering Code	Model #**	Protocol	Compatible Networks*	Occupancy & Daylight	Temperature Reporting	Communication to Luminaire	Drivers
legrand [®] WATTSTOPPER [®]	LMFS1	LMFS-601 & LMFI-111	DLM Wireless	DLM	Integrated	No	Wireless	Advance by Signify
	LMFSD	LMFS-601						Optotronic by eldoLED (Dexal)
COOPER Lighting Solutions	WLXP	OEM-WAA	WaveLinx Wireless	WaveLinx Pro Trellix	Integrated	No	Wireless (WaveLinx Pro Wireless Area Controller)	Advance by Signify
CRESTRON	D11	Specified Driver	DALI	Crestron Zūm Wireless & SpaceBuilder	Enabled	No	Wired	eldoLED ECOdrive
Enlighted	ENL1	SU-5E-IOT	Enlighted RF	Enlighted	Integrated	Yes	Wireless	Advance by Signify
LUTRON	LAWS	A-WN-D01-OCC-WH	DALI, 0-10V	Athena Wireless	Integrated	No	Wireless	Advance by Signify
	LH1	LDE1	EcoSystem	Quantum, Energi Savr Node, Energi TriPak	Enabled	No	Wired	Lutron Hi-Lume

*Not all compatible networks may be listed. **For performance data and additional control system details please visit the connected solutions manufacturer websites. Primary drivers are listed in **bold**. To specify a particular driver please consult factory. †Controls systems supplied by others.

Ordering Guide



Direct Only Linear Circuitry, Zones & Factory Options

HOW TO USE THIS GUIDE

Fill out the worksheet on the following page to specify your requirements for circuitry, zones, and factory options.

Refer to the run chart for standard run configurations, consult factory for custom configurations.

Complete the Totals / Ordering Codes at the bottom of the worksheet and add to your ordering logic on the cut sheet.

Submit the worksheet along with your order.

TOTAL RUN LENGTH: <u>32ft</u>		JOB NAME: _____			FIXTURE TYPE: _____			
EXAMPLE	HOUSING SECTION	SECTION LENGTH	SHARED ELECTRICAL FEED, NORMAL POWER			FACTORY OPTIONS		
			SWITCHING CIRCUIT	DIMMING ZONE	DAYLIGHT ZONE	SEPARATE ELECTRICAL FEEDS		EM
						DAYLIGHT CIRCUIT	EMERGENCY CIRCUIT	
1	8	1C	1Z					1EM
2	8	2C	2Z					
3	8	2C	2Z					
4	8				1DC			
Totals / Ordering Codes		2C	2Z		1DC			1EM

ORDERING: FSM4L-FL-625LF-35K- **2C2Z** -UNV-LD1-G2- **1DC-1EM** -WH-32ft

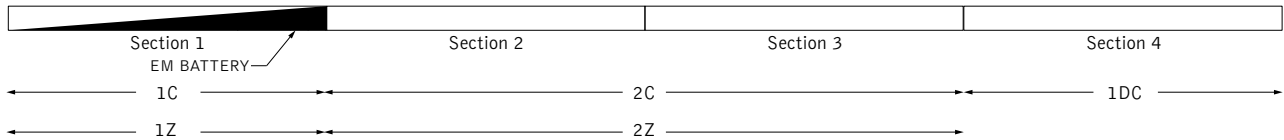

KEY	
C = Switching Circuit Switched Hot / Shared Neutral	DC = Daylight Circuit Switched Hot / Separate Neutral
Z = Dimming Zone Dimming Control Wires	EC = Emergency Circuit Switched Hot / Separate Neutral
DL = Daylight Zone Daylight Dimming Control Wires	EM = Emergency Battery Unswitched Hot / Shared Neutral
	ECD = Emergency Control Device Unswitched Hot / Separate Neutral

DEFAULTS

- Zones and Factory Options illuminate entire sections from 4' to 8' in length.
- One shared or isolated circuit and zone required per housing section.
- Limit of one EM or ECD per housing section.
- Additional electrical feed required for applications greater than three shared circuits and zones.
- Each DC, EC and ECD require an additional electrical feed.
- ECD not available in the same housing section as EC.
- Longer lead times and additional pricing may apply for custom run configurations.

CUSTOM LENGTHS

- If partial illumination of emergency or daylight section is required, indicate in ordering guide and add "partial illumination" in Order Notes. Drawing required.
- Engineering validation required, longer lead times may apply.

Ordering Guide Worksheet

Linear Circuitry, Zones & Factory Options



TOTAL RUN LENGTH: _____		JOB NAME: _____			FIXTURE TYPE: _____			
HOUSING SECTION	SECTION LENGTH	SHARED ELECTRICAL FEED, NORMAL POWER			FACTORY OPTIONS			EM
		SWITCHING CIRCUIT	DIMMING ZONE	DAYLIGHT ZONE	SEPARATE ELECTRICAL FEEDS			
DAYLIGHT CIRCUIT	EMERGENCY CIRCUIT				ECD			
1								
2								
3								
4								
5								
6								
7								
8								
9								
10								
11								
12								
13								
14								
15								
16								
17								
18								
19								
20								
Totals / Ordering Codes								

WORKSHEET

Combine to create Circuits & Zones ordering code

Enter as individual Factory Options

RUN CHART

Run length (ft)	Housing Configuration Section Lengths	Run length (ft)	Housing Configuration Section Lengths	Run length (ft)	Housing Configuration Section Lengths	Run length (ft)	Housing Configuration Section Lengths
9	5 + 4	21	8 + 8 + 5	33	8 + 8 + 8 + 5 + 4	45	8 + 8 + 8 + 8 + 8 + 5
10	6 + 4	22	8 + 8 + 6	34	8 + 8 + 8 + 6 + 4	46	8 + 8 + 8 + 8 + 8 + 6
11	7 + 4	23	8 + 8 + 7	35	8 + 8 + 8 + 7 + 4	47	8 + 8 + 8 + 8 + 8 + 7
12	8 + 4	24	8 + 8 + 8	36	8 + 8 + 8 + 8 + 4	48	8 + 8 + 8 + 8 + 8 + 8
13	8 + 5	25	8 + 8 + 5 + 4	37	8 + 8 + 8 + 8 + 5		
14	8 + 6	26	8 + 8 + 6 + 4	38	8 + 8 + 8 + 8 + 6		
15	8 + 7	27	8 + 8 + 7 + 4	39	8 + 8 + 8 + 8 + 7		
16	8 + 8	28	8 + 8 + 8 + 4	40	8 + 8 + 8 + 8 + 8		
17	8 + 5 + 4	29	8 + 8 + 8 + 5	41	8 + 8 + 8 + 8 + 5 + 4		
18	8 + 6 + 4	30	8 + 8 + 8 + 6	42	8 + 8 + 8 + 8 + 6 + 4		
19	8 + 7 + 4	31	8 + 8 + 8 + 7	43	8 + 8 + 8 + 8 + 7 + 4		
20	8 + 8 + 4	32	8 + 8 + 8 + 8	44	8 + 8 + 8 + 8 + 8 + 4		

Standard run configurations, consult factory for custom configurations.