

# Seem® 4

LED

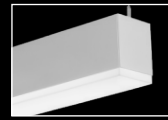

0.5" pop-down lens



1.5" pop-down lens

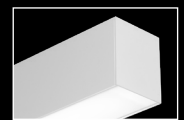

wall mount companion

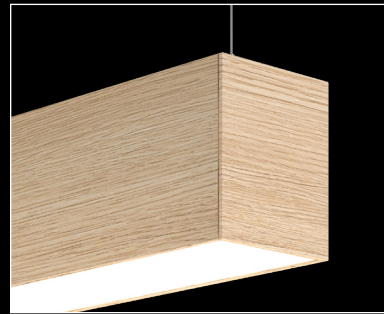

The Naturals collection - Light Oak shown



wall to ceiling companion

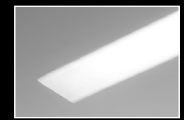

recessed companion

## DIMENSIONAL DATA

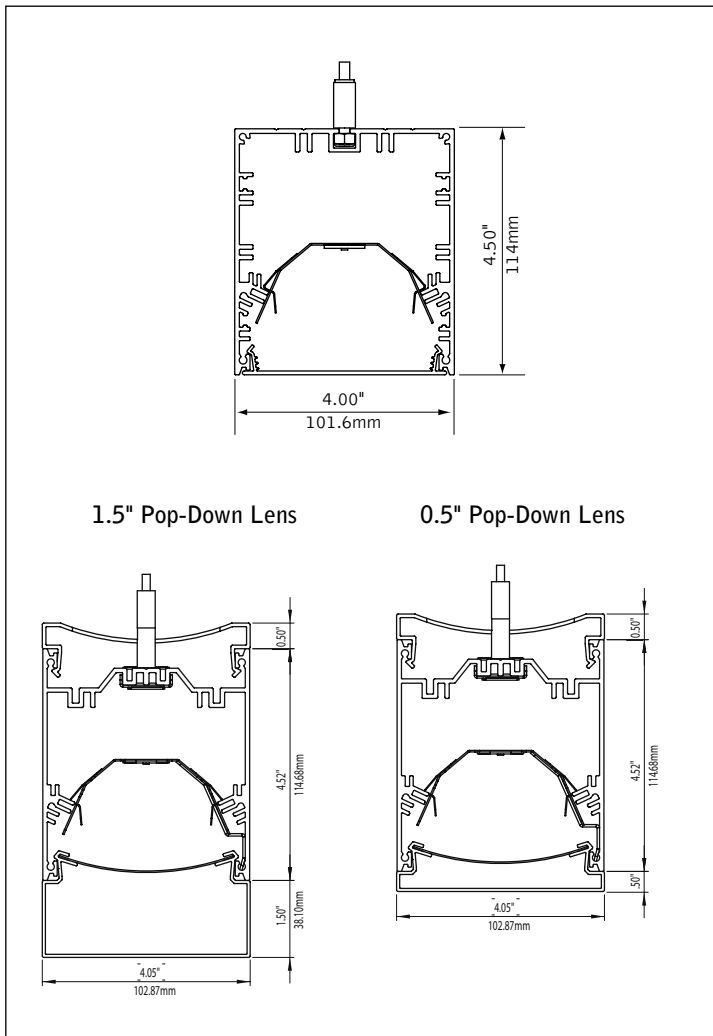

## FEATURES

Narrow extruded aluminum 4" linear direct LED.

Individual units and continuous runs in 1' increments.

Available in flush, asymmetric, asymmetric room fill, batwing, 0.5" or 1.5" pop-down lens.

LED position and lens material optimized to provide the perfect blend of high performance and visual comfort.

Tunable White: Supports human activity, well-being, and preferences with a light quality that evolves throughout the day.

Connected Solutions: Integrates with wired and wireless building lighting control systems.

PoE compatible: Integrates with Power over Ethernet lighting systems via standard, low-voltage wires.

Available with The Naturals, a series of finishes that exude biophilic beauty.

## PERFORMANCE

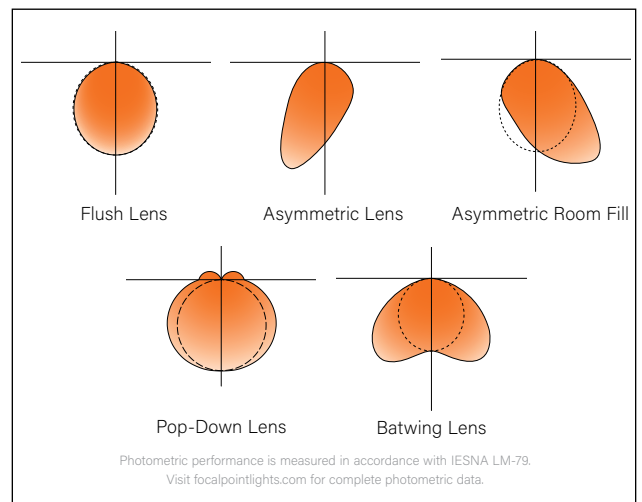

fixture:

project:

**DETAILS**

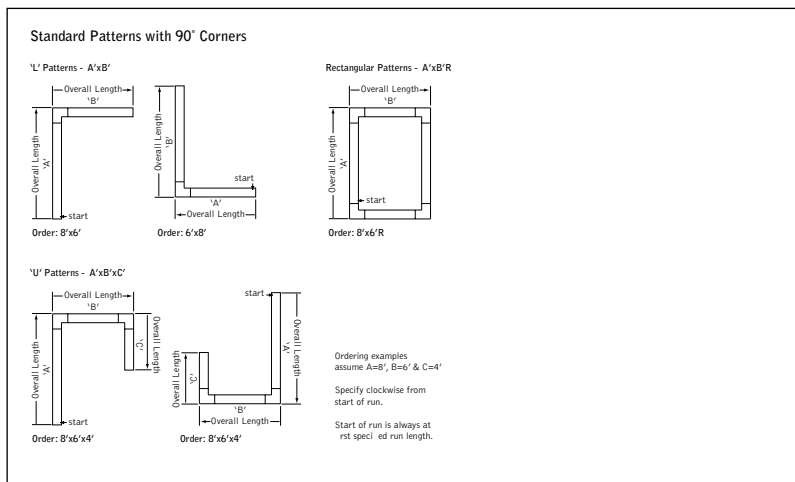

**4' PERFORMANCE CHART**

Lumen Output	Nominal Lumens	BW		FL		AS		AF	
		Tested System Watts	LPW	Tested System Watts	LPW	Tested System Watts	LPW	Tested System Watts	LPW
275LF	1100	8.8	125	9.1	121	8.5	130	8.6	128
375LF	1500	11.3	133	11.7	129	10.8	138	11	137
625LF	2500	19	131	19.9	126	18.3	137	18.5	135
875LF	3500	27	130	27.9	125	25.9	135	26.2	133
1000LF	4000	31.1	129	32.2	124	29.8	134	30.2	132
1125LF	4500	35.4	127	36.6	123	33.9	133	34.4	131
1250LF	5000	39.8	126	41.2	121	38.1	131	38.6	129

Based on 3500K, 80 CRI, 4' lengths. Lumen multiplier: 90+ CRI = 0.87. Lumen output may vary +/- 5%. Actual wattage may vary +/- 5%.

**4' PERFORMANCE CHART - POP-DOWN**

Lumen Output	Nominal Lumens	0.5"		1.5"	
		Tested System Watts	LPW	Tested System Watts	LPW
275LF	1100	11	100	11.9	93
375LF	1500	14.7	102	15.8	95
625LF	2500	25	100	27	93
750LF	3000	30.3	99	32.7	92
875LF	3500	35.7	98	38.6	91
1000LF	4000	41.3	97	44.7	89

Based on 3500K, 80 CRI, 4' lengths. Lumen multiplier: 90+ CRI = 0.87. Lumen output may vary +/- 5%. Actual wattage may vary +/- 5%.

**STANDARD WHITE**

**Luminaire Series**

Seem 4 LED **FSM4LS**

**Shielding**

Asymmetric Lens AS  
 Asymmetric Room Fill AF  
 Batwing Lens BW  
 Flush Satin Lens FL

0.5" Pop-Down Lens (1000LF max.) PD05  
 1.5" Pop-Down Lens (2' - 12' individual units only. 1000LF max.) PD15

**Lumen Output**

275 Lumens per foot (Not available with Lutron) 275LF  
 375 Lumens per foot (Not available with LH1) 375LF  
 625 Lumens per foot (3' min. with LH1) 625LF  
 750 Lumens per foot (Pop-Down Lens only) 750LF  
 875 Lumens per foot 875LF  
 1000 Lumens per foot 1000LF  
 1125 Lumens per foot (BW & FL only) 1125LF  
 1250 Lumens per foot (BW & FL only) 1250LF

**Color Temperature**

2700K, 80+ CRI or 90+ CRI 27K or 927K  
 3000K, 80+ CRI or 90+ CRI 30K or 930K  
 3500K, 80+ CRI or 90+ CRI 35K or 935K  
 4000K, 80+ CRI or 90+ CRI 40K or 940K

**Circuits & Zones**

1 Circuit, non-emergency 1C  
 Consult Ordering Guide on page 4 for multiple circuiting and zoning options \_C\_Z\_DL

**Voltage**

120/277 UNV Volt UNV  
 Low Voltage LV

**Control System & Dimming Level**

0-10V - 10% Dimming LD1  
 0-10V - 1% Dimming L11  
 Low Voltage, PoE compatible (No driver. Not available with EM or EC. LV Voltage only) LVN  
 Lutron Hi-Lume EcoSystem (LDE1) - 1% Dimming LH1  
 DALI 1% Dimming (1000LF max.) D11  
 Wattstopper DLM - 1% Dimming\*\* DLM1  
 Wattstopper Fixture Sensor\*\* LMFS1  
 Low Density - 1% Dimming  
[See sensor layout guide](#)

Wattstopper Fixture Sensor\*\* LMFS2

High Density - 1% Dimming  
[See sensor layout guide](#)

Acuity nLight - 1% Dimming\*\* NLT1

Enlighted Smart Sensor - 1% Dimming\*\* ENL1  
[See sensor layout guide](#)

Encelium CLM Connected Lighting\*\* CLM1

Module - 1% Dimming

Current NX Enabled - 1% Dimming\*\* NXE1

WaveLinX Pro - 1% Dimming\*\* WLXP  
[See sensor layout guide](#)

\*\* (3' min. length, 7' min. length with ECD/EM.)

**Mounting**

24" Cable Suspension C24\_\_  
 48" Cable Suspension C48\_\_  
 96" Cable Suspension C96\_\_  
 (Specify canopy color, see finishes page for options.)

Example: White = C24WH.)  
 (Specify one of the following in place of "C": "J" - for 2' canopies at non-feed locations. CS - for sloped ceiling applications.)

Surface Mount SM

(Not available with CLM1, DLM1, NLT1 or NXE1)

**Factory Options**

(See page 6 for ordering details for DC, EC, EM & ECD.)  
 Black Cord BKCD  
 Daylight Circuit \_DC  
 Emergency Circuit \_EC  
 Emergency Battery Pack \_EM  
 Emergency Control Device \_ECD

†(120/277 Volt only. EM or ECD not available at corners.)

**Finish**

(See finishes page for The Naturals options)

Black BK

Titanium Silver TS

Matte White Housing WH

**Luminaire/Row Length**

Specify in 1' increments X'

(Lengths are nominal, up to 12' individuals available. See Run Chart (page 8) for ordering codes. Smaller increments available, consult factory for details. Leave blank for patterns.)

**Pattern Options**

(3' min. length. Not available with Pop-Down lenses. Consult factory for other pattern options.)

Specify luminaire/row length in 1' increments

'L' pattern A' x B'

'U' pattern A' x B' x C'

Rectangular pattern A' x B'R



Options in orange qualify for the Quickship program. Run lengths in 1' increments, 1000' total. Refer to Quickship Guide for complete details including EM/EC options.

**DETAILS**

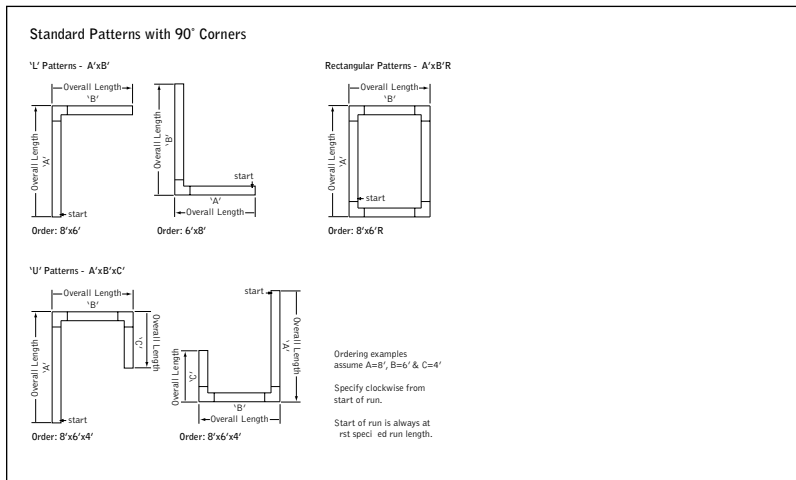

**TUNABLE WHITE**

**Luminaire Series**

Seem 4 LED **FSM4LS**

**Shielding**

- Batwing Lens **BW**
- Flush Satin Lens **FL**
- 0.5" Pop-Down Lens (750LF max.) **PD05**
- 1.5" Pop-Down Lens (2' - 8' individual units only. 750LF max.) **PD15**

**Lumen Output**

- 275 Lumens per foot (BW & FL 3' min. with DITW) **275LF**
- 375 Lumens per foot **375LF**
- 625 Lumens per foot **625LF**
- 750 Lumens per foot (Pop-Down Lens only) **750LF**
- 875 Lumens per foot\* **875LF**
- 1000 Lumens per foot\* **1000LF**
- 1125 Lumens per foot\* **1125LF**

\* (BW & FL only)

**Color Temperature**

- Tunable White: 2700-6500K, 80+ CRI **2765T**
- Tunable White: 2700-6500K, 90+ CRI **92765T**

**Circuits & Zones**

- 1 Circuit, non-emergency **1C**
- Consult Ordering Guide on page 4 for multiple circuiting and zoning options **\_C\_Z\_DL**

**Voltage**

120/277 UNV Volt **UNV**

**Control System & Dimming Level**

- DALI 1% Dimming **D1TW**
- (Default driver offers DT6 control. It requires two addresses, one for intensity & one for CCT tuning. Consult factory for DT8. Extended lead time applies.)
- Acuity nLight - 1% Dimming\*\* **NLT1**
- Enlighted Smart Sensor - 1% Dimming\*\* **ENL1**

\*\* (Consult factory)

**Mounting**

- 24" Cable Suspension **C24**
- 48" Cable Suspension **C48**
- 96" Cable Suspension **C96**

(Specify canopy color, see finishes page for options. Example: White = C24WH.)  
(Specify one of the following in place of "C" J - for 2" canopies at non-feed locations. CS - for sloped ceiling applications.)

**Surface Mount**

(Not available with NLT1) **SM**

**Factory Options**

- (See page 6 for ordering details for DC, EC, EM & ECD.)
- Black Cord **BKCD**
- Daylight Circuit **\_DC**
- Emergency Circuit **\_EC**
- Emergency Battery Pack<sup>†</sup> **\_EM**
- Emergency Control Device<sup>†</sup> **\_ECD**

<sup>†</sup> (Consult factory)

**Finish**

(See finishes page for The Naturals options)

- Black **BK**
- Titanium Silver **TS**
- Matte White Housing **WH**

**Luminaire/Row Length**

Specify in 1' increments **X'**  
(Lengths are nominal, up to 8' individuals available. See Run Chart (page 8) for ordering codes. Smaller increments available, consult factory for details. Leave blank for patterns.)

**Pattern Options**

(3' min. length. Not available with Pop-Down lenses. Consult factory for other pattern options.)

- Specify luminaire/row length in 1' increments **X'**
- 'L' pattern **A' x B'**
- 'U' pattern **A' x B' x C'**
- Rectangular pattern **A' x B'R**

**TW 4' PERFORMANCE CHART**

Lumen Output	Nominal Lumens	Tested System Watts	LPW	
			BW	FL
275LF	1100	13.30	87.3	83.2
375LF	1500	17.34	90.8	86.5
625LF	2500	27.84	94.0	89.5
875LF	3500	37.22	98.9	94.2
1000LF	4000	42.39	99.2	94.4
1125LF	4500	50.27	93.9	89.4

Based on 2700K, 80CRI, 4' lengths. Lumen output may vary +/- 5%. Actual wattage may vary +/- 5%.

**TW 4' PERFORMANCE CHART - POP-DOWN**

Lumen Output	Nominal Lumens	0.5"		1.5"	
		Tested System Watts	LPW	Tested System Watts	LPW
275LF	1100	17.14	64.7	16.33	67.3
375LF	1500	22.79	66.5	21.58	70.0
625LF	2500	35.49	70.6	33.96	73.8
750LF	3000	42.39	70.8	40.28	74.5

Based on 2700K, 80CRI, 4' lengths. Lumen output may vary +/- 5%. Actual wattage may vary +/- 5%.

**Lumen Multipliers**

CRI	Multiplier
80+	1.00
90+	0.89

**Wattage Multipliers**

CCT	Multiplier
2700K	1.00
3000K	0.92
3500K	0.88
4000K	0.86
5000K	0.85
5700K	0.87
6500K	0.90

## SPECIFICATIONS

### LED System

Proprietary linear LED module incorporates premium LEDs on a robust platform to achieve excellent thermal management. LEDs are placed to promote a uniform appearance. Available in 2700K, 3000K, 3500K or 4000K with CRI>80 or CRI>90, 3 SDCM or Tunable White (2700K-6500K), CRI>80, >90. 3500K and 4000K with CRI>90 have a cyanosis observation index (COI) of 3.3 or less. LED modules and drivers are replaceable from below.

### Construction

9-12' luminaires ship on 13' (157") pallets, forklift extensions of 72" are required to avoid damage. One piece extruded aluminum housing. Die cast aluminum end caps. 2' unit weight: 10 lbs, 3' unit weight: 14 lbs, 4' unit weight: 18 lbs, 5' unit weight: 22 lbs, 12' unit weight: 48 lbs.

### Optic

Reflectors fabricated of 22 Ga. steel finished in High Reflectance White powder coat. Flush and Batwing extruded acrylic lens .085" thick with satin finish, up to 12' continuous. Pop-Down lenses extruded acrylic lens .06" thick with frosted finish.

### Electrical

Luminaires are pre-wired with factory installed branch circuit wiring and over-molded quick connects. Standard 120-277V constant current driver includes 0-10V analog dimming. Dimming range 100% to 10%. Power factor > .9. PoE compatible: Integrates with Power over Ethernet lighting systems via standard, low-voltage wires. PoE runs require an independent PoE node and power feed for each luminaire section.

### Emergency

Emergency Battery output - 10 watts for 90 minutes. Maximum mounting height: 20.18ft. Emergency Circuit with Connected Solutions (DLM1, LMFS1, LMFS1, NLT1, ENL1, CLM1, NXE1, WLXP) shipped standard with leads to connect UL924 compliant device, by others.

### Labels

UL and cUL listed. Suitable for Dry or Damp Locations, indoor use only.

### Finish

Polyester powder coat applied over a multi-stage pre-treatment. Canopy and cord white as standard. The Naturals: 100% low VOC vinyl.

### Lumen Maintenance

Reported: L70 > 61,000 hours  
L90 > 61,000 hours  
Calculated: L70 at > 480,000 hours  
L90 at > 128,000 hours  
(Derived from EPA TM-21 calculator. Based on typical conditions, consult factory for additional data.)

### Reliability

At Focal Point, our products are designed to stand the test of time. Each luminaire is engineered using superior components, manufactured with the utmost care and rigorously tested. Contact us for reliability data.

### Warranty

LED system rated for operation in ambient environments up to 25°C. 5-year limited warranty.

## MOUNTING INFORMATION

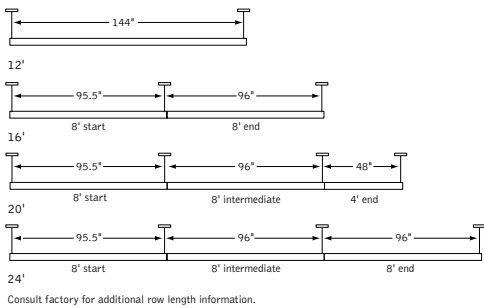

## DIRECT ASYMMETRIC Standard Application Example

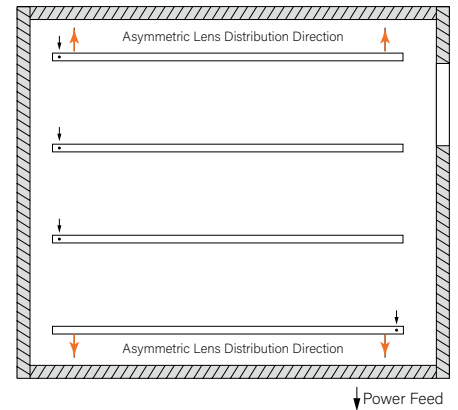
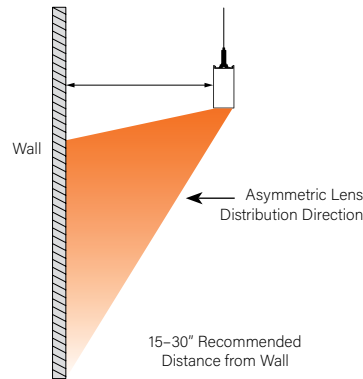

## DIRECT ASYMMETRIC ROOM FILL Standard Application Example

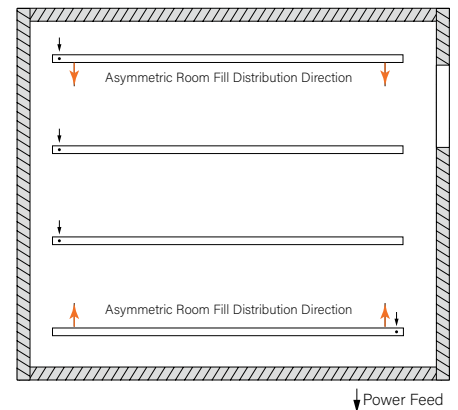
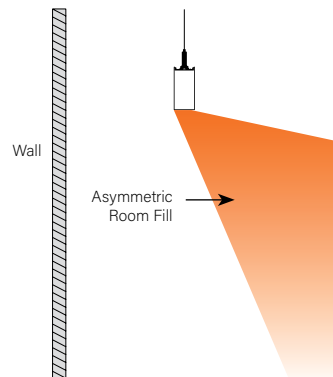

Focal Point provides flexibility in meeting the needs of each project by integrating with several building lighting control systems. A variety of sensors, drivers and other components can be specified that allow the luminaires to communicate with wired and wireless networks. All zoning can be digitally reconfigured through the application software. Daylight harvesting, occupancy sensing, integration with HVAC systems, and individual controls enable the monitoring and modulating of light levels and temperature in order to save energy, reduce costs and maximize occupants' comfort. All Connected Solutions luminaires require a compatible building control system.†

Connected Solution	Ordering Code	Model #**	Protocol	Compatible Networks*	Occupancy & Daylight	Temperature Reporting	Communication to Luminaire	Drivers
 <b>legrand</b> ® WATTSTOPPER®	DLM1	LMFC-011	DLM	DLM	Enabled	No	Wired 	<b>Advance by Signify</b> , Optotronic by eldoLED
	LMFS1	LMFS-601 & LMFI-111	DLM Wireless	DLM	Enabled	No	Wireless	<b>Advance by Signify</b>
LMFSD	LMFS-601	Optotronic by eldoLED (Dexal)						
 <b>COOPER</b> Lighting Solutions	WLXP	OEM-WAA	WaveLinx Wireless	WaveLinx Pro Trellix	Enabled	No	Wireless (WaveLinx Pro Wireless Area Controller)	<b>Advance by Signify</b>
 <b>CRESTRON</b>	D11	Specified Driver	DALI	Crestron Züm Wireless & SpaceBuilder	Enabled	No	Wired	<b>eldoLED ECOdrive</b>
	L11		0-10V					<b>Advance by Signify</b>
 <b>ENCELIUM</b>	CLM1	ZBHA-CLM-DIM-ENC	ZigBee	Encelium X Light Management System	Enabled	No	Wireless	<b>Optotronic by eldoLED</b> Advance by Signify
 <b>Enlighted</b>	ENL1	SU-5E-IOT	Enlighted RF	Enlighted	Integrated	Yes	Wireless	<b>Advance by Signify</b>
 <b>LUTRON</b>	LH1	LDE1	EcoSystem	Quantum, Energi Savr Node, Energi TriPak	Enabled	No	Wired	<b>Lutron Hi-Lume</b>
 <b>nLIGHT</b>	NLT1	nEPS-60-IO	nLight	nLight	Enabled	No	Wired 	<b>eldoLED ECOdrive</b> , eldoLED SOLOdrive
	NXE1	NXFM-LV	NX	NX Distributed Intelligence	Enabled	No	Wired 	<b>Optotronic by eldoLED</b>

\*Not all compatible networks may be listed. \*\*For performance data and additional control system details please visit the connected solutions manufacturer websites. Primary drivers are listed in **bold**. To specify a particular driver please consult factory. †Controls systems supplied by others.

# Ordering Guide

## Linear Circuitry, Zones & Factory Options

### HOW TO USE THIS GUIDE

Fill out the worksheet on the following page to specify your requirements for circuitry, zones, and factory options.

Refer to the run chart for standard run configurations, consult factory for custom configurations.

Complete the Totals / Ordering Codes at the bottom of the worksheet and add to your ordering logic on the cut sheet.

Submit the worksheet along with your order.

TOTAL RUN LENGTH: <u>32ft</u>		JOB NAME: _____			FIXTURE TYPE: _____			
HOUSING SECTION	SECTION LENGTH	SHARED ELECTRICAL FEED, NORMAL POWER			FACTORY OPTIONS			
		SWITCHING CIRCUIT	DIMMING ZONE	DAYLIGHT ZONE	SEPARATE ELECTRICAL FEEDS			EM
DAYLIGHT CIRCUIT	EMERGENCY CIRCUIT				ECD			
1	8	1C	1Z					1EM
2	8	2C	2Z					
3	8	2C	2Z					
4	8				1DC			
<b>Totals / Ordering Codes</b>		<b>2C</b>	<b>2Z</b>		<b>1DC</b>			<b>1EM</b>

ORDERING: FSM4LS-FL-625LF-35K- **2C2Z** -UNV-LD1-C24WH- **1DC-1EM** -WH-32ft

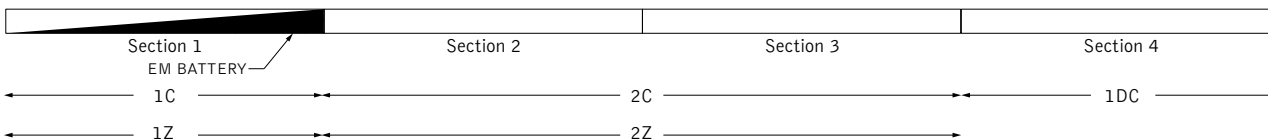

KEY	
<b>C = Switching Circuit</b> Switched Hot / Shared Neutral	<b>DC = Daylight Circuit</b> Switched Hot / Separate Neutral
<b>Z = Dimming Zone</b> Dimming Control Wires	<b>EC = Emergency Circuit</b> Switched Hot / Separate Neutral
<b>DL = Daylight Zone</b> Daylight Dimming Control Wires	<b>EM = Emergency Battery</b> Unswitched Hot / Shared Neutral
	<b>ECD = Emergency Control Device</b> Unswitched Hot / Separate Neutral

### DEFAULTS

- Zones and Factory Options illuminate entire sections from 4' to 8' in length.
- One shared or isolated circuit and zone required per housing section.
- Limit of one EM or ECD per housing section.
- Additional electrical feed required for applications greater than three shared circuits and zones.
- Each DC, EC and ECD require an additional electrical feed.
- ECD not available in the same housing section as EC.
- Longer lead times and additional pricing may apply for custom run configurations.

### CUSTOM LENGTHS

- If partial illumination of emergency or daylight section is required, indicate in ordering guide and add "partial illumination" in Order Notes. Drawing required.
- Engineering validation required, longer lead times may apply.

# Ordering Guide Worksheet

Linear Circuitry, Zones & Factory Options

TOTAL RUN LENGTH: _____		JOB NAME: _____			FIXTURE TYPE: _____			
HOUSING SECTION	SECTION LENGTH	SHARED ELECTRICAL FEED, NORMAL POWER			FACTORY OPTIONS			EM
		SWITCHING CIRCUIT	DIMMING ZONE	DAYLIGHT ZONE	SEPARATE ELECTRICAL FEEDS			
DAYLIGHT CIRCUIT	EMERGENCY CIRCUIT				ECD			
1								
2								
3								
4								
5								
6								
7								
8								
9								
10								
11								
12								
13								
14								
15								
16								
17								
18								
19								
20								
<b>Totals / Ordering Codes</b>								

WORKSHEET

Combine to create Circuits & Zones ordering code

Enter as individual Factory Options

## RUN CHART

Run Length (ft)	Housing Configuration Section Lengths	Ordering Code	Run Length (ft)	Housing Configuration Section Lengths	Ordering Code	Run Length (ft)	Housing Configuration Section Lengths	Ordering Code
9	5 + 4	9	19	8 + 7 + 4	19	35	8 + 8 + 8 + 7 + 4	35
	9	9(IND)	20	8 + 8 + 4	20	36	8 + 8 + 8 + 8 + 4	36
	6 + 4	10	21	8 + 8 + 5	21	37	8 + 8 + 8 + 8 + 5	37
10	5 + 5	10(5+5)	22	8 + 8 + 6	22	38	8 + 8 + 8 + 8 + 6	38
	10	10(IND)	23	8 + 8 + 7	23	39	8 + 8 + 8 + 8 + 7	39
	7 + 4	11	24	8 + 8 + 8	24	40	8 + 8 + 8 + 8 + 8	40
11	11	11(IND)	25	8 + 8 + 5 + 4	25	41	8 + 8 + 8 + 8 + 5 + 4	41
	8 + 4	12	26	8 + 8 + 6 + 4	26	42	8 + 8 + 8 + 8 + 6 + 4	42
12	6 + 6	12(6+6)	27	8 + 8 + 7 + 4	27	43	8 + 8 + 8 + 8 + 7 + 4	43
	12	12(IND)	28	8 + 8 + 8 + 4	28	44	8 + 8 + 8 + 8 + 8 + 4	44
13	8 + 5	13	29	8 + 8 + 8 + 5	29	45	8 + 8 + 8 + 8 + 8 + 5	45
14	8 + 6	14	30	8 + 8 + 8 + 6	30	46	8 + 8 + 8 + 8 + 8 + 6	46
15	8 + 7	15	31	8 + 8 + 8 + 7	31	47	8 + 8 + 8 + 8 + 8 + 7	47
16	8 + 8	16	32	8 + 8 + 8 + 8	32	48	8 + 8 + 8 + 8 + 8 + 8	48
17	8 + 5 + 4	17	33	8 + 8 + 8 + 5 + 4	33			
18	8 + 6 + 4	18	34	8 + 8 + 8 + 6 + 4	34			

Standard run configurations, consult factory for custom configurations.

# Finishes



## STANDARD FINISHES



WHITE WH BLACK BK TITANIUM SILVER TS

## THE NATURALS (25% SCALE)

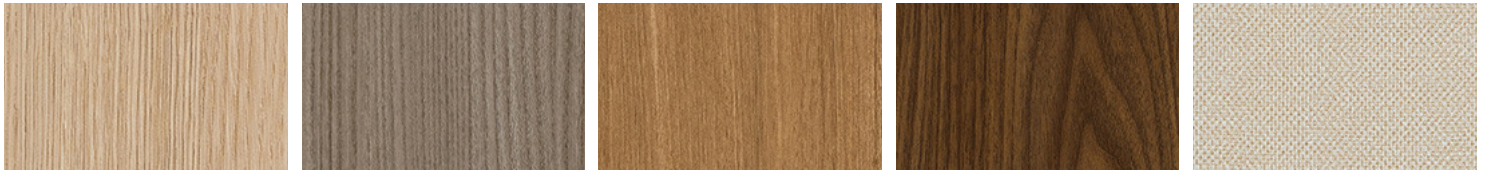

LIGHT OAK LOK GRAY ELM GRE CHESTNUT CHT WALNUT WLT WOVEN LINEN WLN