

Seem® 4

LED

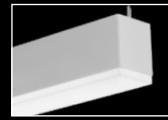

0.5" pop-down lens

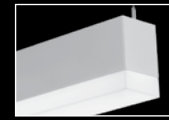

1.5" pop-down lens



wall mount companion

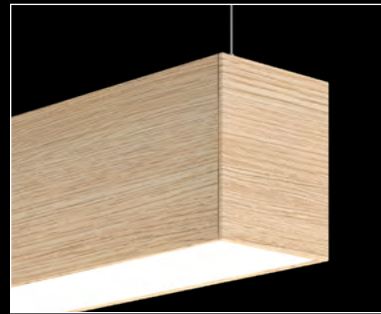

The Naturals collection - Light Oak shown



wall to ceiling companion



recessed companion

DIMENSIONAL DATA

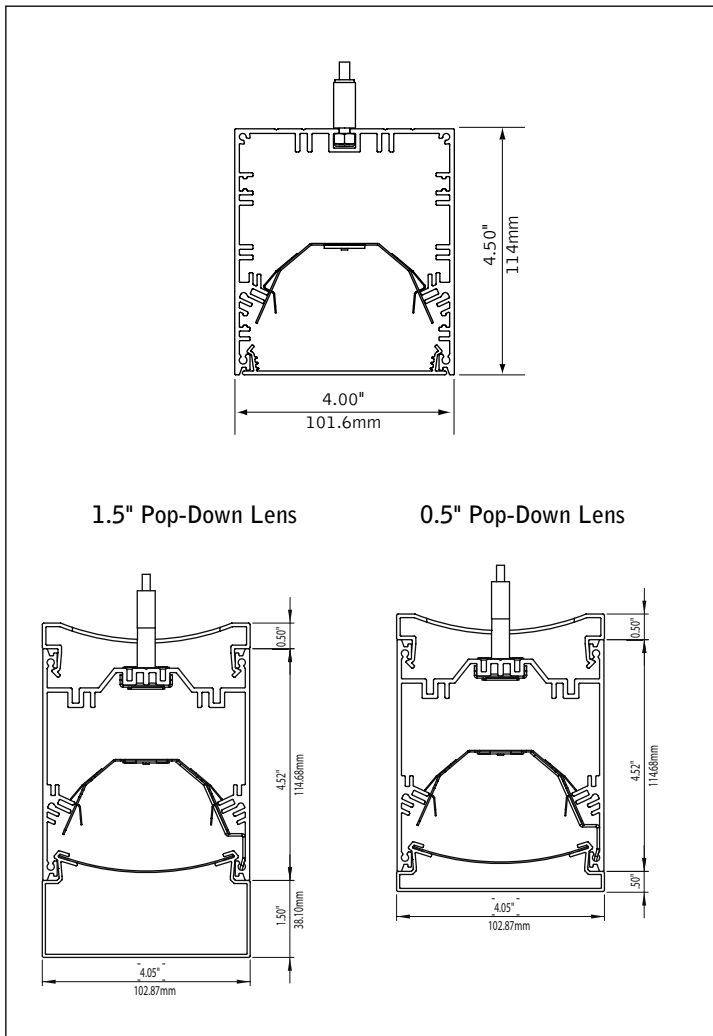

FEATURES

Narrow extruded aluminum 4" linear direct LED.

Individual units and continuous runs in 1' increments.

Available in flush, asymmetric, asymmetric room fill, batwing, 0.5" or 1.5" pop-down lens.

LED position and lens material optimized to provide the perfect blend of high performance and visual comfort.

Tunable White: Supports human activity, well-being, and preferences with a light quality that evolves throughout the day.

Connected Solutions: Integrates with wired and wireless building lighting control systems.

PoE compatible: Integrates with Power over Ethernet lighting systems via standard, low-voltage wires.

Available with The Naturals, a series of finishes that exude biophilic beauty.

PERFORMANCE

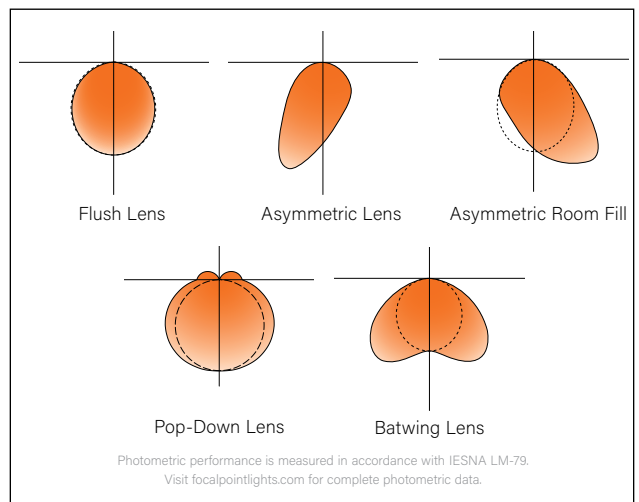

fixture:

project:

DETAILS

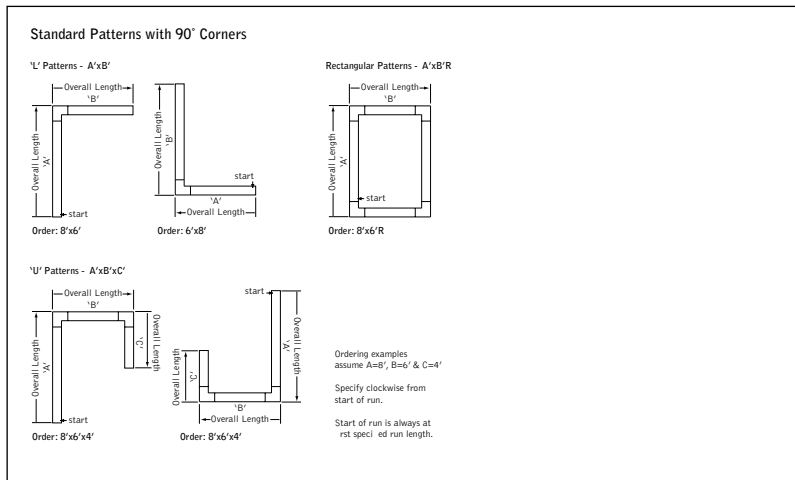

4' PERFORMANCE CHART

Lumen Output	Nominal Lumens	BW		FL		AS		AF	
		Tested System Watts	LPW	Tested System Watts	LPW	Tested System Watts	LPW	Tested System Watts	LPW
275LF	1100	8.8	125	9.1	121	8.5	130	8.6	128
375LF	1500	11.3	133	11.7	129	10.8	138	11	137
625LF	2500	19	131	19.9	126	18.3	137	18.5	135
875LF	3500	27	130	27.9	125	25.9	135	26.2	133
1000LF	4000	31.1	129	32.2	124	29.8	134	30.2	132
1125LF	4500	35.4	127	36.6	123	33.9	133	34.4	131
1250LF	5000	39.8	126	41.2	121	38.1	131	38.6	129

Based on 3500K, 80 CRI, 4' lengths. Lumen multiplier: 90+ CRI = 0.87. Lumen output may vary +/- 5%. Actual wattage may vary +/- 5%.

4' PERFORMANCE CHART - POP-DOWN

Lumen Output	Nominal Lumens	0.5"		1.5"	
		Tested System Watts	LPW	Tested System Watts	LPW
275LF	1100	11	100	11.9	93
375LF	1500	14.7	102	15.8	95
625LF	2500	25	100	27	93
750LF	3000	30.3	99	32.7	92
875LF	3500	35.7	98	38.6	91
1000LF	4000	41.3	97	44.7	89

Based on 3500K, 80 CRI, 4' lengths. Lumen multiplier: 90+ CRI = 0.87. Lumen output may vary +/- 5%. Actual wattage may vary +/- 5%.

STANDARD WHITE

Luminaire Series

Seem 4 LED

FSM4LS

Shielding

Asymmetric Lens AS

Asymmetric Room Fill AF

Batwing Lens BW

Flush Satin Lens FL

0.5" Pop-Down Lens (1000LF max.) PD05

1.5" Pop-Down Lens (2' - 12' individual units only, 1000LF max.) PD15

Lumen Output

275 Lumens per foot (Not available with Lutron) 275LF

375 Lumens per foot (Not available with LHI) 375LF

625 Lumens per foot (3' min. with LHI) 625LF

750 Lumens per foot (Pop-Down Lens only) 750LF

875 Lumens per foot 875LF

1000 Lumens per foot 1000LF

1125 Lumens per foot (BW & FL only) 1125LF

1250 Lumens per foot (BW & FL only) 1250LF

Color Temperature

2700K, 80+ CRI or 90+ CRI 27K or 927K

3000K, 80+ CRI or 90+ CRI 30K or 930K

3500K, 80+ CRI or 90+ CRI 35K or 935K

4000K, 80+ CRI or 90+ CRI 40K or 940K

Circuits & Zones

1 Circuit, non-emergency 1C

Consult Ordering Guide on page 4 for multiple circuiting and zoning options

_C_Z_DL

Voltage

120/277 UNV Volt UNV

Low Voltage LV

Control System & Dimming Level

0-10V - 10% Dimming LD1

0-10V - 1% Dimming L11

Low Voltage, PoE compatible LVN

(No driver. Not available with EM or EC. LV Voltage only)

Lutron Hi-Lume EcoSystem (LDE1) - 1% Dimming LH1

DALI 1% Dimming (1000LF max.) D11

Wattstopper DLM - 1% Dimming** DLM1

Wattstopper Fixture Sensor** 2 LMFS1

Low Density - 1% Dimming

See sensor layout guide

Wattstopper Fixture Sensor** 2 LMFS2

High Density - 1% Dimming

See sensor layout guide

Lutron Athena Wireless Node**1 LAW1

Lutron Athena Wireless Sensor**1 2 LAWS

(Remote mounted sensor. See sensor layout guide)

Acuity nLight - 1% Dimming** NLT1

Encelium CLM Connected Lighting** CLM1

Module - 1% Dimming

Current NX Enabled - 1% Dimming** NXE1

WaveLinux Pro - 1% Dimming** 2 WLXP

See sensor layout guide

** (3' min. length, 7' min. length with ECD/EM.)

1 (0-10V standard, consult factory for DALI)

2 (Not available with PD05 and PD15 lenses)

Mounting

24" Cable Suspension C24

48" Cable Suspension C48

96" Cable Suspension C96

(Specify canopy color, see finishes page for options.)

Example: White = C24WH1

(Specify one of the following in place of "C" - for 2' canopies at non-feed locations. CS - for sloped ceiling applications.)

Surface Mount

(Not available with LAW1, CLM1, DLM1, NLT1 or NXE1)

Factory Options

(See page 6 for ordering details for DC, EC, EM & ECD.)

Black Cord BKCD

Daylight Circuit _DC

Emergency Circuit _EC

Emergency Battery Pack _EM

Emergency Control Device _ECD

† (120/277 Volt only. EM or ECD not available at corners.)

Finish

(See finishes page for The Naturals options)

Black BK

Titanium Silver TS

Matte White Housing WH

Luminaire/Row Length

Specify in 1' increments X'

(Lengths are nominal, up to 12' individuals available. See Run Chart (page 8) for ordering codes. Smaller increments available, consult factory for details. Leave blank for patterns.)

Pattern Options

(3' min. length. Not available with Pop-Down lenses. Consult factory for other pattern options.)

Specify luminaire/row length in 1' increments

'L' pattern A' x B'

'U' pattern A' x B' x C'

Rectangular pattern A' x B'R



Options in orange qualify for the Quickship program. Run lengths in 1' increments, 1000' total. Refer to Quickship Guide for complete details including EM/EC options.

fixture:

project:

DETAILS

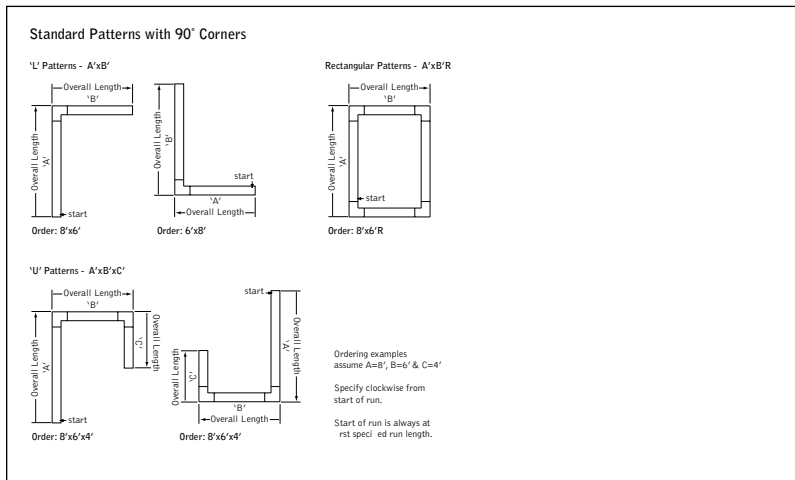

TUNABLE WHITE

Luminaire Series

Seem 4 LED FSM4LS

FSM4LS

Shielding

- Batwing Lens BW
 - Flush Satin Lens FL
 - 0.5" Pop-Down Lens (750LF max.) PD05
 - 1.5" Pop-Down Lens PD15
- (2' - 8' individual units only. 750LF max.)

Lumen Output

- 275 Lumens per foot (BW & FL 3' min. with DITW) 275LF
 - 375 Lumens per foot 375LF
 - 625 Lumens per foot 625LF
 - 750 Lumens per foot (Pop-Down Lens only) 750LF
 - 875 Lumens per foot* 875LF
 - 1000 Lumens per foot* 1000LF
 - 1125 Lumens per foot* 1125LF
- * (BW & FL only)

Color Temperature

- Tunable White: 2700-6500K, 80+ CRI 2765T
- Tunable White: 2700-6500K, 90+ CRI 92765T

Circuits & Zones

- 1 Circuit, non-emergency 1C
- Consult Ordering Guide on page 4 for multiple circuiting and zoning options _C_Z_DL

Voltage

120/277 UNV Volt UNV

UNV

Control System & Dimming Level

- DALI 1% Dimming D1TW
 - (Default driver offers DT6 control. It requires two addresses, one for intensity & one for CCT tuning. Consult factory for DT8. Extended lead time applies.)
 - Acuity nLight - 1% Dimming** NLT1
- ** (Consult factory)

Mounting

- 24" Cable Suspension C24
- 48" Cable Suspension C48
- 96" Cable Suspension C96

(Specify canopy color, see finishes page for options. Example: White = C24WH.) (Specify one of the following in place of "C": J - for 2' canopies at non-feed locations. CS - for sloped ceiling applications.)

Surface Mount

(Not available with NLT1) SM

Factory Options

- (See page 6 for ordering details for DC, EC, EM & ECD.)
 - Black Cord BKCD
 - Daylight Circuit _DC
 - Emergency Circuit _EC
 - Emergency Battery Pack† _EM
 - Emergency Control Device† _ECD
- † (Consult factory)

Finish

(See finishes page for The Naturals options)

- Black BK
- Titanium Silver TS
- Matte White Housing WH

Luminaire/Row Length

Specify in 1' increments X'

(Lengths are nominal, up to 8' individuals available. See Run Chart (page 8) for ordering codes. Smaller increments available, consult factory for details. Leave blank for patterns.)

Pattern Options

(3' min. length. Not available with Pop-Down lenses. Consult factory for other pattern options.)

Specify luminaire/row length in 1' increments X'

- 'L' pattern A' x B'
- 'U' pattern A' x B' x C'
- Rectangular pattern A' x B'R

TW 4' PERFORMANCE CHART

Lumen Output	Nominal Lumens	Tested System Watts	LPW	
			BW	FL
275LF	1100	13.30	87.3	83.2
375LF	1500	17.34	90.8	86.5
625LF	2500	27.84	94.0	89.5
875LF	3500	37.22	98.9	94.2
1000LF	4000	42.39	99.2	94.4
1125LF	4500	50.27	93.9	89.4

Based on 2700K, 80CRI, 4' lengths. Lumen output may vary +/- 5%. Actual wattage may vary +/- 5%.

TW 4' PERFORMANCE CHART - POP-DOWN

Lumen Output	Nominal Lumens	0.5"		1.5"	
		Tested System Watts	LPW	Tested System Watts	LPW
275LF	1100	17.14	64.7	16.33	67.3
375LF	1500	22.79	66.5	21.58	70.0
625LF	2500	35.49	70.6	33.96	73.8
750LF	3000	42.39	70.8	40.28	74.5

Based on 2700K, 80CRI, 4' lengths. Lumen output may vary +/- 5%. Actual wattage may vary +/- 5%.

Lumen Multipliers

CRI	Multiplier
80+	1.00
90+	0.89

Wattage Multipliers

CCT	Multiplier
2700K	1.00
3000K	0.92
3500K	0.88
4000K	0.86
5000K	0.85
5700K	0.87
6500K	0.90

SPECIFICATIONS

LED System

Proprietary linear LED module incorporates premium LEDs on a robust platform to achieve excellent thermal management. LEDs are placed to promote a uniform appearance. Available in 2700K, 3000K, 3500K or 4000K with CRI>80 or CRI>90, 3 SDCM or Tunable White (2700K-6500K), CRI>80, >90. 3500K and 4000K with CRI>90 have a cyanosis observation index (COI) of 3.3 or less. LED modules and drivers are replaceable from below.

Construction

9-12' luminaires ship on 13' (157") pallets, forklift extensions of 72" are required to avoid damage. One piece extruded aluminum housing. Die cast aluminum end caps. 2' unit weight: 10 lbs., 3' unit weight: 14 lbs., 4' unit weight: 18 lbs., 5' unit weight: 22 lbs., 12' unit weight: 48 lbs.

Optic

Reflectors fabricated of 22 Ga. steel finished in High Reflectance White powder coat. Flush and Batwing extruded acrylic lens .085" thick with satin finish, up to 12' continuous. Pop-Down lenses extruded acrylic lens .06" thick with frosted finish.

Electrical

Luminaires are pre-wired with factory installed branch circuit wiring and over-molded quick connects. Standard 120-277V constant current driver includes 0-10V analog dimming. Dimming range 100% to 10%. Power factor > .9. PoE compatible: Integrates with Power over Ethernet lighting systems via standard, low-voltage wires. PoE runs require an independent PoE node and power feed for each luminaire section.

Emergency

Emergency Battery output - 10 watts for 90 minutes. Maximum mounting height: 20.18ft. Emergency Circuit with Connected Solutions (DLM1, LMFS1, LMFS1, NLT1, CLM1, NXE1, WLXP) shipped standard with leads to connect UL924 compliant device, by others.

Labels

UL and cUL listed. Suitable for Dry or Damp Locations, indoor use only.

Finish

Polyester powder coat applied over a multi-stage pre-treatment. Canopy and cord white as standard. The Naturals: 100% low VOC vinyl.

Lumen Maintenance

Reported: L70 > 61,000 hours
L90 > 61,000 hours
Calculated: L70 at > 480,000 hours
L90 at > 128,000 hours
(Derived from EPA TM-21 calculator. Based on typical conditions, consult factory for additional data.)

Reliability

At Focal Point, our products are designed to stand the test of time. Each luminaire is engineered using superior components, manufactured with the utmost care and rigorously tested. Contact us for reliability data.

Warranty

LED system rated for operation in ambient environments up to 25°C. 5-year limited warranty.

MOUNTING INFORMATION

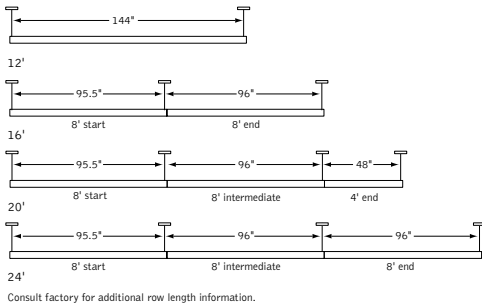

DIRECT ASYMMETRIC Standard Application Example

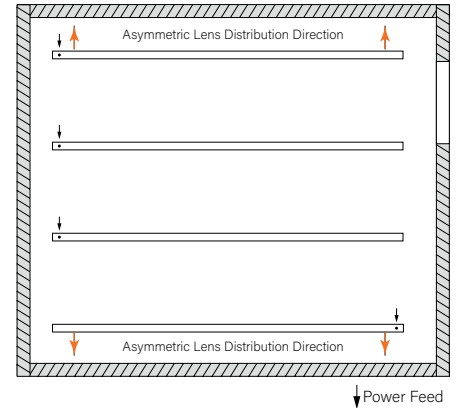
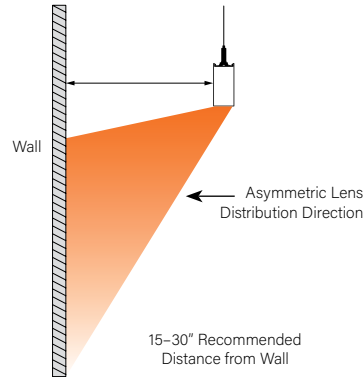

DIRECT ASYMMETRIC ROOM FILL Standard Application Example

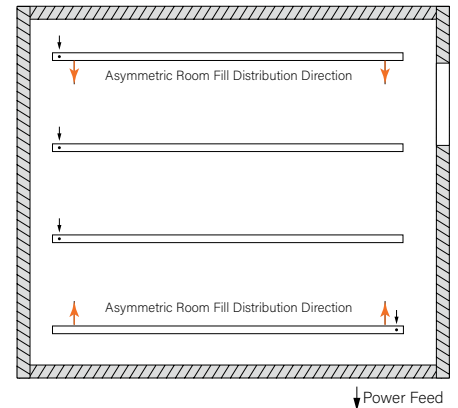
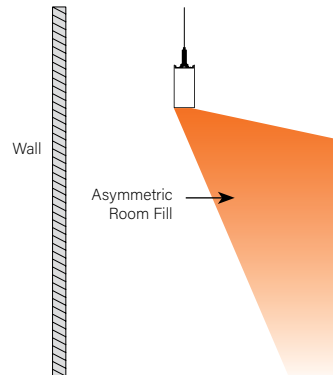

Focal Point provides flexibility in meeting the needs of each project by integrating with several building lighting control systems. A variety of sensors, drivers and other components can be specified that allow the luminaires to communicate with wired and wireless networks. All zoning can be digitally reconfigured through the application software. Daylight harvesting, occupancy sensing, integration with HVAC systems, and individual controls enable the monitoring and modulating of light levels and temperature in order to save energy, reduce costs and maximize occupants' comfort. All Connected Solutions luminaires require a compatible building control system.†

Connected Solution	Ordering Code	Model #**	Protocol	Compatible Networks*	Occupancy & Daylight	Temperature Reporting	Communication to Luminaire	Drivers
 legrand WATTSTOPPER®	DLM1	LMFC-011	DLM	DLM	Enabled	No	Wired 	Advance by Signify , Optotronic by eldoLED
	LMFS1	LMFS-601 & LMFI-111	DLM Wireless	DLM	Enabled	No	Wireless	Advance by Signify
LMFSD	LMFS-601	Optotronic by eldoLED (Dexal)						
 COOPER Lighting Solutions	WLXP	OEM-WAA	WaveLinx Wireless	WaveLinx Pro Trellix	Enabled	No	Wireless (WaveLinx Pro Wireless Area Controller)	Advance by Signify
 CRESTRON	D11	Specified Driver	DALI	Crestron Züm Wireless & SpaceBuilder	Enabled	No	Wired	eldoLED ECOdrive
	L11		0-10V					Advance by Signify
 ENCELIUM	CLM1	ZBHA-CLM-DIM-ENC	ZigBee	Encelium X Light Management System	Enabled	No	Wireless	Optotronic by eldoLED Advance by Signify
 LUTRON	LAW1	A-WN-D01-RF-WH	DALI, 0-10V	Athena Wireless	Enabled	No	Wireless	Advance by Signify
	LAWS	A-WN-D01-OCC-WH	DALI, 0-10V	Athena Wireless	Integrated	No	Wireless	Advance by Signify
	LH1	LDE1	EcoSystem	Quantum, Energi Savr Node, Energi TriPak	Enabled	No	Wired	Lutron Hi-Lume
 nLIGHT	NLT1	nEPS-60-IO	nLight	nLight	Enabled	No	Wired 	eldoLED ECOdrive , eldoLED SOLOdrive
 NXP LIGHTING CONTROLS	NXE1	NXFM-LV	NX	NX Distributed Intelligence	Enabled	No	Wired 	Optotronic by eldoLED

*Not all compatible networks may be listed. **For performance data and additional control system details please visit the connected solutions manufacturer websites. Primary drivers are listed in **bold**. To specify a particular driver please consult factory. †Controls systems supplied by others.

Ordering Guide

Linear Circuitry, Zones & Factory Options

HOW TO USE THIS GUIDE

Fill out the worksheet on the following page to specify your requirements for circuitry, zones, and factory options.

Refer to the run chart for standard run configurations, consult factory for custom configurations.

Complete the Totals / Ordering Codes at the bottom of the worksheet and add to your ordering logic on the cut sheet.

Submit the worksheet along with your order.

TOTAL RUN LENGTH: <u>32ft</u>		JOB NAME: _____			FIXTURE TYPE: _____			
HOUSING SECTION	SECTION LENGTH	SHARED ELECTRICAL FEED, NORMAL POWER			FACTORY OPTIONS			
		SWITCHING CIRCUIT	DIMMING ZONE	DAYLIGHT ZONE	SEPARATE ELECTRICAL FEEDS			EM
DAYLIGHT CIRCUIT	EMERGENCY CIRCUIT				ECD			
1	8	1C	1Z					1EM
2	8	2C	2Z					
3	8	2C	2Z					
4	8				1DC			
Totals / Ordering Codes		2C	2Z		1DC			1EM

ORDERING: FSM4LS-FL-625LF-35K- **2C2Z** -UNV-LD1-C24WH- **1DC-1EM** -WH-32ft

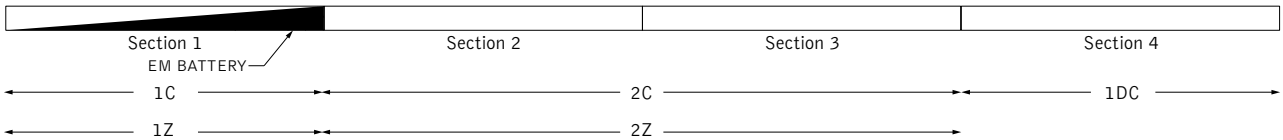

KEY	
C = Switching Circuit Switched Hot / Shared Neutral	DC = Daylight Circuit Switched Hot / Separate Neutral
Z = Dimming Zone Dimming Control Wires	EC = Emergency Circuit Switched Hot / Separate Neutral
DL = Daylight Zone Daylight Dimming Control Wires	EM = Emergency Battery Unswitched Hot / Shared Neutral
	ECD = Emergency Control Device Unswitched Hot / Separate Neutral

DEFAULTS

- Zones and Factory Options illuminate entire sections from 4' to 8' in length.
- One shared or isolated circuit and zone required per housing section.
- Limit of one EM or ECD per housing section.
- Additional electrical feed required for applications greater than three shared circuits and zones.
- Each DC, EC and ECD require an additional electrical feed.
- ECD not available in the same housing section as EC.
- Longer lead times and additional pricing may apply for custom run configurations.

CUSTOM LENGTHS

- If partial illumination of emergency or daylight section is required, indicate in ordering guide and add "partial illumination" in Order Notes. Drawing required.
- Engineering validation required, longer lead times may apply.

Ordering Guide Worksheet

Linear Circuitry, Zones & Factory Options

TOTAL RUN LENGTH: _____		JOB NAME: _____			FIXTURE TYPE: _____			
HOUSING SECTION	SECTION LENGTH	SHARED ELECTRICAL FEED, NORMAL POWER			FACTORY OPTIONS			EM
		SWITCHING CIRCUIT	DIMMING ZONE	DAYLIGHT ZONE	SEPARATE ELECTRICAL FEEDS			
DAYLIGHT CIRCUIT	EMERGENCY CIRCUIT				ECD			
1								
2								
3								
4								
5								
6								
7								
8								
9								
10								
11								
12								
13								
14								
15								
16								
17								
18								
19								
20								
Totals / Ordering Codes								

WORKSHEET

Combine to create Circuits & Zones ordering code

Enter as individual Factory Options

RUN CHART

Run Length (ft)	Housing Configuration Section Lengths	Ordering Code	Run Length (ft)	Housing Configuration Section Lengths	Ordering Code	Run Length (ft)	Housing Configuration Section Lengths	Ordering Code
9	5 + 4	9	19	8 + 7 + 4	19	35	8 + 8 + 8 + 7 + 4	35
	9	9(IND)	20	8 + 8 + 4	20	36	8 + 8 + 8 + 8 + 4	36
	6 + 4	10	21	8 + 8 + 5	21	37	8 + 8 + 8 + 8 + 5	37
10	5 + 5	10(5+5)	22	8 + 8 + 6	22	38	8 + 8 + 8 + 8 + 6	38
	10	10(IND)	23	8 + 8 + 7	23	39	8 + 8 + 8 + 8 + 7	39
	7 + 4	11	24	8 + 8 + 8	24	40	8 + 8 + 8 + 8 + 8	40
11	11	11(IND)	25	8 + 8 + 5 + 4	25	41	8 + 8 + 8 + 8 + 5 + 4	41
	8 + 4	12	26	8 + 8 + 6 + 4	26	42	8 + 8 + 8 + 8 + 6 + 4	42
12	6 + 6	12(6+6)	27	8 + 8 + 7 + 4	27	43	8 + 8 + 8 + 8 + 7 + 4	43
	12	12(IND)	28	8 + 8 + 8 + 4	28	44	8 + 8 + 8 + 8 + 8 + 4	44
13	8 + 5	13	29	8 + 8 + 8 + 5	29	45	8 + 8 + 8 + 8 + 8 + 5	45
14	8 + 6	14	30	8 + 8 + 8 + 6	30	46	8 + 8 + 8 + 8 + 8 + 6	46
15	8 + 7	15	31	8 + 8 + 8 + 7	31	47	8 + 8 + 8 + 8 + 8 + 7	47
16	8 + 8	16	32	8 + 8 + 8 + 8	32	48	8 + 8 + 8 + 8 + 8 + 8	48
17	8 + 5 + 4	17	33	8 + 8 + 8 + 5 + 4	33			
18	8 + 6 + 4	18	34	8 + 8 + 8 + 6 + 4	34			

Standard run configurations, consult factory for custom configurations.

Finishes



STANDARD FINISHES



WHITE WH BLACK BK TITANIUM SILVER TS

THE NATURALS (25% SCALE)

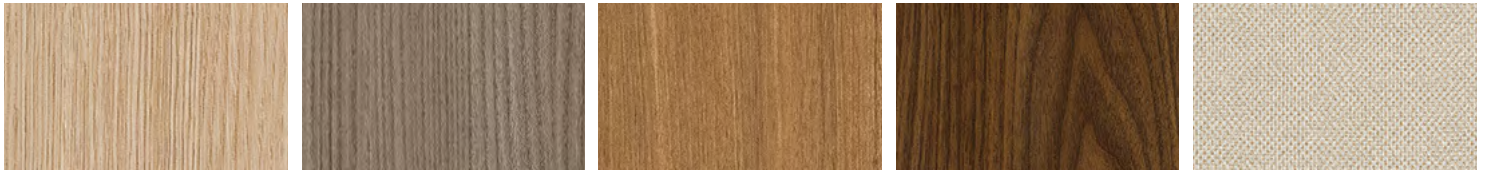

LIGHT OAK LOK GRAY ELM GRE CHESTNUT CHT WALNUT WLT WOVEN LINEN WLN