

# Seem<sup>®</sup> 6 Drywall/Hard/Specialty Ceiling

LED

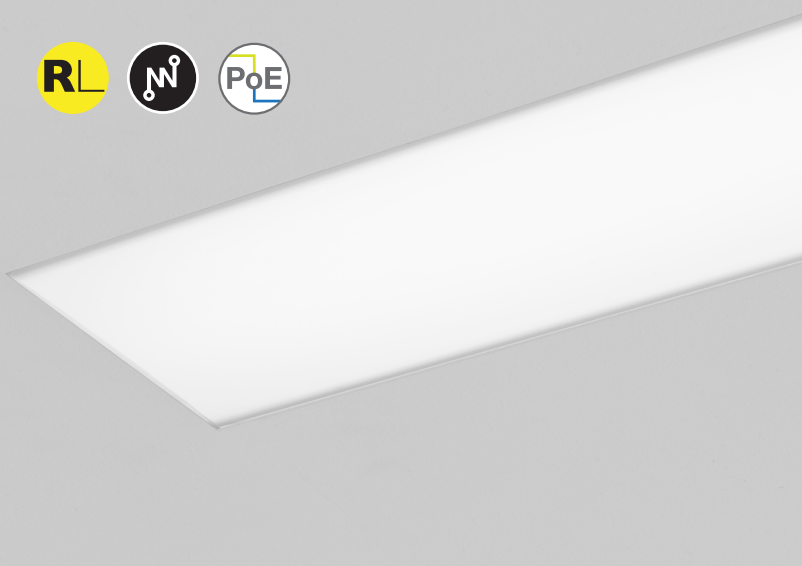

trimless mud-in



trim flange

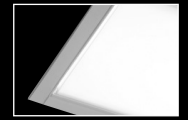

end detail



corner detail

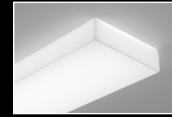

pop-down lens companion

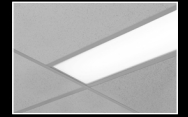

grid ceiling companion

## DIMENSIONAL DATA

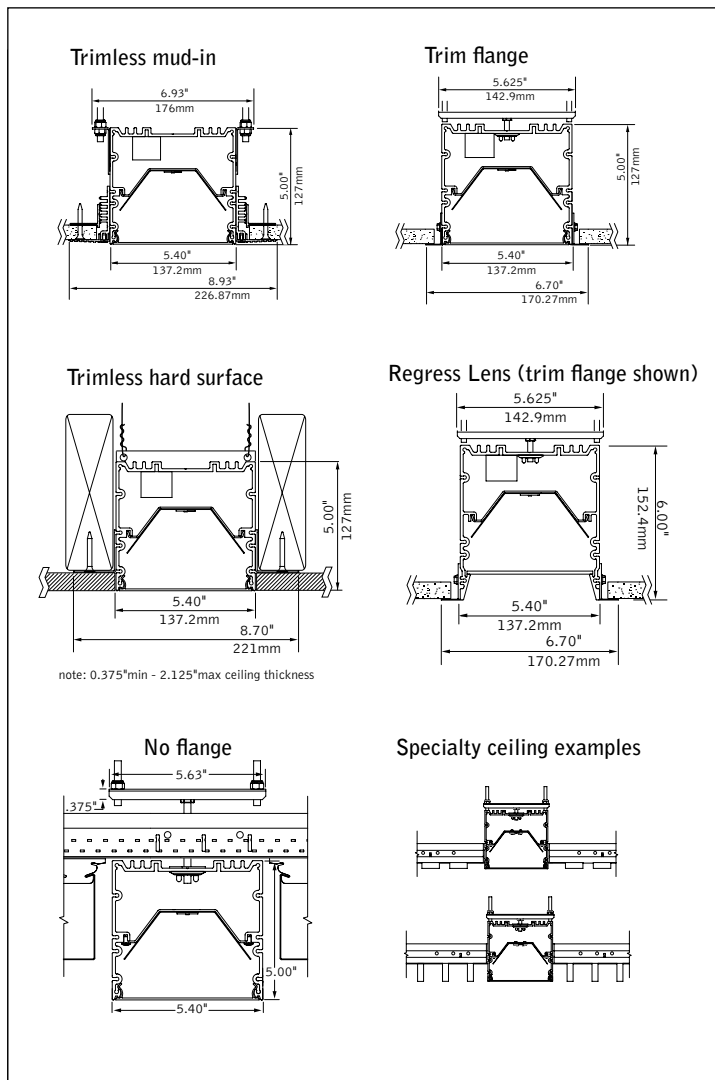

## FEATURES

- Narrow extruded aluminum 6" aperture recessed slot LED.
- Integrates with ceiling or wall in a variety of mounting styles for a clean, unobtrusive aesthetic.
- Individual units and continuous runs in 1" increments.
- Frosted acrylic lens provides uninterrupted illumination, without pixels or shadows.
- LED position and lens material optimized to provide the perfect blend of high performance and visual comfort.
- Connected Solutions: Integrates with wired and wireless building lighting control systems.
- PoE compatible: Integrates with Power over Ethernet lighting systems via standard, low-voltage wires.

## DISTRIBUTIONS

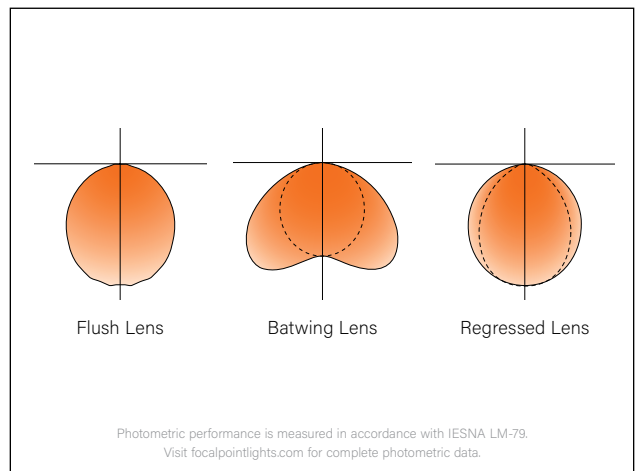

fixture:

project:

**DETAILS**

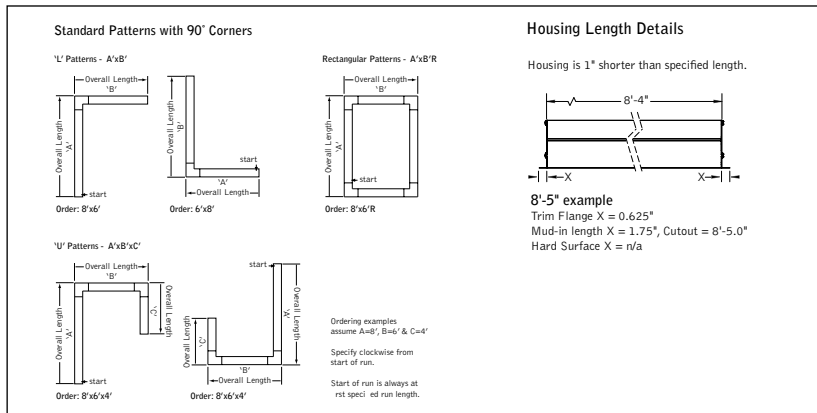

**SPECIFICATIONS**

**LED System**

Proprietary linear LED module incorporates premium LEDs on a robust platform to achieve excellent thermal management. LEDs are placed to promote a uniform appearance. Available in 2700K, 3000K, 3500K or 4000K with CRI>80 or CRI>90, 3 SDCM. 3500K and 4000K with CRI>90 have a cyanosis observation index (COI) of 3.3 or less. LED modules and drivers are replaceable from below.

**Construction**

One piece extruded aluminum housing, 20 Ga. steel end caps. Housing for new construction applications. XFW acceptable for use with wood, consult factory for Type IC availability. 2' unit weight: 18 lbs., 3' unit weight: 24 lbs., 4' unit weight: 30 lbs., 5' unit weight: 36 lbs.

**Optic**

Reflectors fabricated of 22 Ga. steel finished in High Reflectance White powder coat. Extruded acrylic lens .085" thick with satin finish, up to 8' continuous.

**Electrical**

Luminaires are pre-wired with factory installed branch circuit wiring and over-molded quick connects. Standard 120-277V constant current driver includes 0-10V analog dimming. Dimming range 100% to 10%. Power factor > .9. PoE compatible: Integrates with Power over Ethernet lighting systems via standard, low-voltage wires. PoE runs require an independent PoE node and power feed for each luminaire section.

**Emergency**

Emergency Battery output - 10 watts for 90 minutes. Maximum mounting height: 18.8ft. Emergency Circuit with Connected Solutions (LMFS1, LMFSD, ENL1, WLXP) shipped standard with leads to connect UL924 compliant device, by others.

**Labels**

UL and cUL listed. Suitable for Dry or Damp Locations, indoor use only.

**Finish**

Polyester powder coat applied over a multi-stage pre-treatment.

**Lumen Maintenance**

Reported: L70 > 61,000 hours      Calculated: L70 at > 350,000 hours  
 L90 > 61,000 hours              L90 at > 90,000 hours

(Derived from EPA TM-21 calculator. Based on typical conditions, consult factory for additional data.)

**Reliability**

At Focal Point, our products are designed to stand the test of time. Each luminaire is engineered using superior components, manufactured with the utmost care and rigorously tested. Contact us for reliability data.

**Warranty**

LED system rated for operation in ambient environments up to 25°C. 5-year limited warranty.

**4' PERFORMANCE CHART**

| Lumen Output per foot | Tested System Watts | Delivered Lumens   LPW |    |      |     | Tested System Watts | Delivered Lumens   LPW |    |      |     |
|-----------------------|---------------------|------------------------|----|------|-----|---------------------|------------------------|----|------|-----|
|                       |                     | FL                     |    | BW   |     |                     | SR                     |    | SRXP |     |
| 375LF                 | 18.2                | 1737                   | 95 | 1939 | 106 | 17.2                | 1675                   | 97 | 1855 | 108 |
| 625LF                 | 31.2                | 2949                   | 94 | 3291 | 105 | 29.4                | 2872                   | 98 | 3180 | 108 |
| 875LF                 | 44.2                | 4066                   | 92 | 4539 | 103 | 41.7                | 4030                   | 97 | 4462 | 107 |
| 1000LF                | 50.8                | 4636                   | 91 | 5175 | 102 | 47.9                | 4531                   | 95 | 5017 | 105 |
| 1125LF                | 53.6                | 4874                   | 91 | 5441 | 101 | 52.2                | 4867                   | 93 | 5389 | 103 |
| 1250LF                | 60.8                | 5412                   | 89 | 6041 | 99  | 57.3                | 5407                   | 94 | 5987 | 104 |

Based on 3500K, 80 CRI, 4' lengths. Lumen multipliers: . Lumen output may vary +/- 5%. Actual wattage may vary +/- 5%.

**ORDERING**

**Luminaire Series**

Seem 6 LED **FSM6L**

**Shielding**

Batwing Lens **BW**

Flush Lens **FL**

Regressed Lens\* **SR**

Regressed High Performance Lens\* **SRXP**

**Lumen Output**

375 Lumens per foot **375LF**

625 Lumens per foot **625LF**

875 Lumens per foot **875LF**

1000 Lumens per foot **1000LF**

1125 Lumens per foot **1125LF**

1250 Lumens per foot **1250LF**

**Color Temperature**

2700K, 80+ CRI **or** 90+ CRI **27K or 927K**

3000K, 80+ CRI **or** 90+ CRI **30K or 930K**

3500K, 80+ CRI **or** 90+ CRI **35K or 935K**

4000K, 80+ CRI **or** 90+ CRI **40K or 940K**

**Circuits & Zones**

1 Circuit, non-emergency **1C**

Consult Ordering Guide on page 4 for multiple circuiting and zoning options **\_C\_Z\_DL**

**Voltage**

120/277 UNV Volt **UNV**

Low voltage **LV**

**Control System & Dimming Level**

0-10V - 10% Dimming **LD1**

0-10V - 1% Dimming **L11**

Low Voltage, PoE compatible **LVN**

Lutron Hi-Lume EcoSystem (LDE1) - 1% Dimming **LH1**

DALI 1% Dimming **D11**

Wattstopper Fixture Sensor\*\*\*1 **LMFS1**

Low Density - 1% Dimming **LMFSD**

Wattstopper Fixture Sensor\*\*\*1 **LMFSD**

High Density - 1% Dimming **ENL1**

Enlighted Smart Sensor - 1% Dimming\*\*\*1 **ENL1**

WaveLinx Pro - 1% Dimming\*\*\*1 **WLXP**

\*\* (3' minimum length, with ECD/EM - 7' minimum, XF1, XF2 and XFF only)

1 (See sensor layout guide)

**Ceiling Configurations**

No Flange for specialty ceilings **NF**

(Ex. slat, panel, cloud systems. 3' minimum with Lutron Drivers)

Trim Flange Drywall **TF**

(3' minimum with Lutron Drivers)

Trim Flange Wood **TFW**

(3' minimum with Lutron Drivers)

Mud-in Trimless, pre-set for 1/2" Drywall **XF1**

Mud-in Trimless, pre-set for 5/8" Drywall **XF2**

Mud-in Trimless, set thickness in field **XFF**

(Mounting equipment assembled in field)

Non-Drywall Hard Surface **XFN**

Hard Surface, Wood **XFW**

**Factory Options**

(See Ordering Guide on page 4 for ordering details for DC, EC, EM & ECD.)

Chicago Plenum **CP**

(Not available with Flex Whip)

Daylight Circuit **\_DC**

Emergency Circuit **\_EC**

Emergency Battery Pack† **\_EM**

Emergency Control Device† **\_ECD**

† (4' minimum, 6' minimum with patterns. 120/277 Volt only. Not available at corners.)

6' New York City Flex Whip (120V) **FNY1**

6' New York City Flex Whip (277V) **FNY2**

6' Flex Whip **FW**

**Finish**

Matte White Housing **WH**

**Luminaire Length**

Specify luminaire/row length in " increments **\_ft\_in**

(2' minimum, lengths are nominal 1" increments. Housing length is 1" shorter than specified. Leave blank for patterns. Smaller increments available, consult factory.)

**Pattern Options**

(4' minimum length)









'L' pattern **A' x B'**

'U' pattern **A' x B' x C'**

Rectangular pattern **A' x B' R**

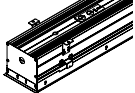
(Consult factory for other pattern options)

Focal Point provides flexibility in meeting the needs of each project by integrating with several building lighting control systems. A variety of sensors, drivers and other components can be specified that allow the luminaires to communicate with wired and wireless networks. All zoning can be digitally reconfigured through the application software. Daylight harvesting, occupancy sensing, integration with HVAC systems, and individual controls enable the monitoring and modulating of light levels and temperature in order to save energy, reduce costs and maximize occupants' comfort. All Connected Solutions luminaires require a compatible building control system.†

| Connected Solution  | Ordering Code | Model #**           | Protocol          | Compatible Networks*                     | Occupancy & Daylight | Temperature Reporting | Communication to Luminaire                          | Drivers                              |
|---|---------------|---------------------|-------------------|--|----------------------|-----------------------|---|--------------------------------------|
| <br><br>WATTSTOPPER®  | LMFS1         | LMFS-601 & LMFI-111 | DLM Wireless      | DLM                                      | Enabled              | No                    | Wireless  | <b>Advance by Signify</b>            |
|   | LMFSD         | LMFS-601            |                   |  |                      |                       |   | <b>Optotronic by eldoLED (Dexal)</b> |
| <br>  | WLXP          | OEM-WAA             | WaveLinx Wireless | WaveLinx Pro Trellix                     | Enabled              | No                    | Wireless<br>(WaveLinx Pro Wireless Area Controller) | <b>Advance by Signify</b>            |
| <br><br><small>Connections located under access panel.</small>    | D11           | Specified Driver    | DALI              | Crestron Züm Wireless & SpaceBuilder     | Enabled              | No                    | Wired   | <b>eldoLED ECOdrive</b>              |
|   | L11           |                     | 0-10V             |  |                      |                       |   | <b>Advance by Signify</b>            |
| <br>  | ENL1          | SU-5E-IOT           | Enlighted RF      | Enlighted                                | Integrated           | Yes                   | Wireless  | <b>Advance by Signify</b>            |
| <br><br><small>Connections located under access panel.</small> | LH1           | LDE1                | EcoSystem         | Quantum, Energi Savr Node, Energi TriPak | Enabled              | No                    | Wired   | <b>Lutron Hi-Lume</b>                |

\*Not all compatible networks may be listed. \*\*For performance data and additional control system details please visit the connected solutions manufacturer websites. Primary drivers are listed in **bold**. To specify a particular driver please consult factory. †Controls systems supplied by others.

# Ordering Guide



Direct Only Linear Circuitry, Zones & Factory Options

## HOW TO USE THIS GUIDE

Fill out the worksheet on the following page to specify your requirements for circuitry, zones, and factory options.

Refer to the run chart for standard run configurations, consult factory for custom configurations.

Complete the Totals / Ordering Codes at the bottom of the worksheet and add to your ordering logic on the cut sheet.

Submit the worksheet along with your order.

| TOTAL RUN LENGTH: <u>32ft</u>  |                | JOB NAME: _____                      |              |               | FIXTURE TYPE: _____       |                   |     |            |
|--------------------------------|----------------|--------------------------------------|--------------|---------------|---------------------------|-------------------|-----|------------|
| HOUSING SECTION                | SECTION LENGTH | SHARED ELECTRICAL FEED, NORMAL POWER |              |               | FACTORY OPTIONS           |                   |     |            |
|                                |                | SWITCHING CIRCUIT                    | DIMMING ZONE | DAYLIGHT ZONE | SEPARATE ELECTRICAL FEEDS |                   |     | EM         |
|                                |                |                                      |              |               | DAYLIGHT CIRCUIT          | EMERGENCY CIRCUIT | ECD |            |
| 1                              | 8              | 1C                                   | 1Z           |               |                           |                   |     | 1EM        |
| 2                              | 8              | 2C                                   | 2Z           |               |                           |                   |     |            |
| 3                              | 8              | 2C                                   | 2Z           |               |                           |                   |     |            |
| 4                              | 8              |                                      |              |               | 1DC                       |                   |     |            |
| <b>Totals / Ordering Codes</b> |                | <b>2C</b>                            | <b>2Z</b>    |               | <b>1DC</b>                |                   |     | <b>1EM</b> |

ORDERING: FSM4L-FL-625LF-35K- **2C2Z** -UNV-LD1-G2- **1DC-1EM** -WH-32ft

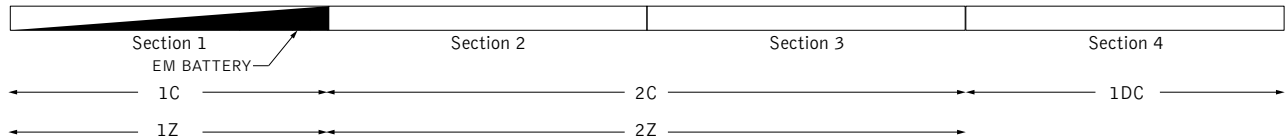

| KEY   |  |
|---|--|
| <b>C = Switching Circuit</b><br>Switched Hot / Shared Neutral | <b>DC = Daylight Circuit</b><br>Switched Hot / Separate Neutral            |
| <b>Z = Dimming Zone</b><br>Dimming Control Wires              | <b>EC = Emergency Circuit</b><br>Switched Hot / Separate Neutral           |
| <b>DL = Daylight Zone</b><br>Daylight Dimming Control Wires   | <b>EM = Emergency Battery</b><br>Unswitched Hot / Shared Neutral           |
|   | <b>ECD = Emergency Control Device</b><br>Unswitched Hot / Separate Neutral |

## DEFAULTS

- Zones and Factory Options illuminate entire sections from 4' to 8' in length.
- One shared or isolated circuit and zone required per housing section.
- Limit of one EM or ECD per housing section.
- Additional electrical feed required for applications greater than three shared circuits and zones.
- Each DC, EC and ECD require an additional electrical feed.
- ECD not available in the same housing section as EC.
- Longer lead times and additional pricing may apply for custom run configurations.

## CUSTOM LENGTHS

- If partial illumination of emergency or daylight section is required, indicate in ordering guide and add "partial illumination" in Order Notes. Drawing required.
- Engineering validation required, longer lead times may apply.

# Ordering Guide Worksheet

Linear Circuitry, Zones & Factory Options



FOCAL POINT®

| TOTAL RUN LENGTH: _____        |                   | JOB NAME: _____                      |              |               | FIXTURE TYPE: _____       |  |  |    |
|--------------------------------|-------------------|--------------------------------------|--------------|---------------|---------------------------|--|--|----|
| HOUSING SECTION                | SECTION LENGTH    | SHARED ELECTRICAL FEED, NORMAL POWER |              |               | FACTORY OPTIONS           |  |  | EM |
|                                |                   | SWITCHING CIRCUIT                    | DIMMING ZONE | DAYLIGHT ZONE | SEPARATE ELECTRICAL FEEDS |  |  |    |
| DAYLIGHT CIRCUIT               | EMERGENCY CIRCUIT |                                      |              |               | ECD                       |  |  |    |
| 1                              |                   |                                      |              |               |                           |  |  |    |
| 2                              |                   |                                      |              |               |                           |  |  |    |
| 3                              |                   |                                      |              |               |                           |  |  |    |
| 4                              |                   |                                      |              |               |                           |  |  |    |
| 5                              |                   |                                      |              |               |                           |  |  |    |
| 6                              |                   |                                      |              |               |                           |  |  |    |
| 7                              |                   |                                      |              |               |                           |  |  |    |
| 8                              |                   |                                      |              |               |                           |  |  |    |
| 9                              |                   |                                      |              |               |                           |  |  |    |
| 10                             |                   |                                      |              |               |                           |  |  |    |
| 11                             |                   |                                      |              |               |                           |  |  |    |
| 12                             |                   |                                      |              |               |                           |  |  |    |
| 13                             |                   |                                      |              |               |                           |  |  |    |
| 14                             |                   |                                      |              |               |                           |  |  |    |
| 15                             |                   |                                      |              |               |                           |  |  |    |
| 16                             |                   |                                      |              |               |                           |  |  |    |
| 17                             |                   |                                      |              |               |                           |  |  |    |
| 18                             |                   |                                      |              |               |                           |  |  |    |
| 19                             |                   |                                      |              |               |                           |  |  |    |
| 20                             |                   |                                      |              |               |                           |  |  |    |
| <b>Totals / Ordering Codes</b> |                   |                                      |              |               |                           |  |  |    |

WORKSHEET

Combine to create Circuits & Zones ordering code

Enter as individual Factory Options

## RUN CHART

| Run length (ft) | Housing Configuration Section Lengths | Run length (ft) | Housing Configuration Section Lengths | Run length (ft) | Housing Configuration Section Lengths | Run length (ft) | Housing Configuration Section Lengths |
|-----------------|---------------------------------------|-----------------|---------------------------------------|-----------------|---------------------------------------|-----------------|---------------------------------------|
| 9               | 5 + 4                                 | 21              | 8 + 8 + 5                             | 33              | 8 + 8 + 8 + 5 + 4                     | 45              | 8 + 8 + 8 + 8 + 8 + 5                 |
| 10              | 6 + 4                                 | 22              | 8 + 8 + 6                             | 34              | 8 + 8 + 8 + 6 + 4                     | 46              | 8 + 8 + 8 + 8 + 8 + 6                 |
| 11              | 7 + 4                                 | 23              | 8 + 8 + 7                             | 35              | 8 + 8 + 8 + 7 + 4                     | 47              | 8 + 8 + 8 + 8 + 8 + 7                 |
| 12              | 8 + 4                                 | 24              | 8 + 8 + 8                             | 36              | 8 + 8 + 8 + 8 + 4                     | 48              | 8 + 8 + 8 + 8 + 8 + 8                 |
| 13              | 8 + 5                                 | 25              | 8 + 8 + 5 + 4                         | 37              | 8 + 8 + 8 + 8 + 5                     |                 |                                       |
| 14              | 8 + 6                                 | 26              | 8 + 8 + 6 + 4                         | 38              | 8 + 8 + 8 + 8 + 6                     |                 |                                       |
| 15              | 8 + 7                                 | 27              | 8 + 8 + 7 + 4                         | 39              | 8 + 8 + 8 + 8 + 7                     |                 |                                       |
| 16              | 8 + 8                                 | 28              | 8 + 8 + 8 + 4                         | 40              | 8 + 8 + 8 + 8 + 8                     |                 |                                       |
| 17              | 8 + 5 + 4                             | 29              | 8 + 8 + 8 + 5                         | 41              | 8 + 8 + 8 + 8 + 5 + 4                 |                 |                                       |
| 18              | 8 + 6 + 4                             | 30              | 8 + 8 + 8 + 6                         | 42              | 8 + 8 + 8 + 8 + 6 + 4                 |                 |                                       |
| 19              | 8 + 7 + 4                             | 31              | 8 + 8 + 8 + 7                         | 43              | 8 + 8 + 8 + 8 + 7 + 4                 |                 |                                       |
| 20              | 8 + 8 + 4                             | 32              | 8 + 8 + 8 + 8                         | 44              | 8 + 8 + 8 + 8 + 8 + 4                 |                 |                                       |

Standard run configurations, consult factory for custom configurations.